

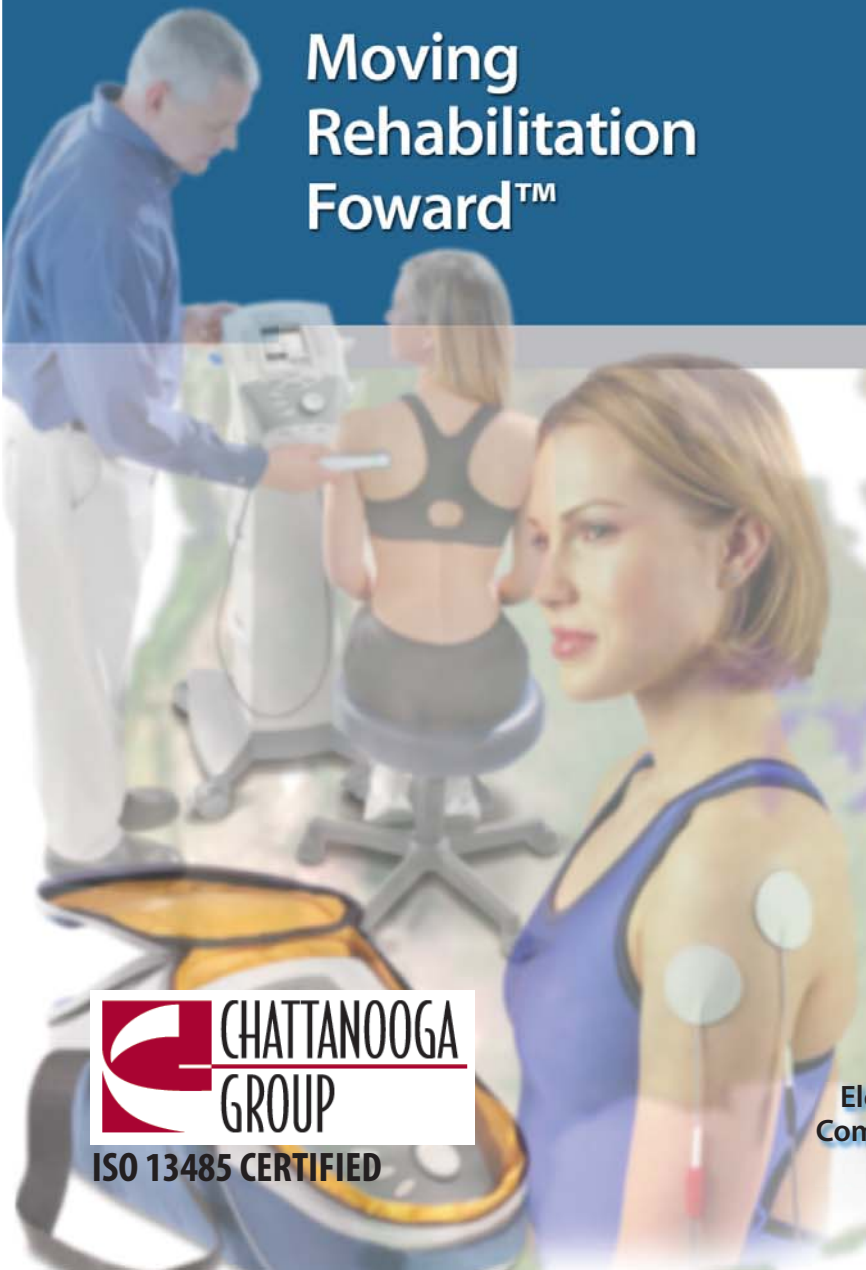

Moving  
Rehabilitation  
Forward™

# Intelect LEGENDXT®



## User Manual Operation & Installation Instructions for: Therapy Systems

- 2760- Two Channel Combination System
- 2788- Four Channel Combination System
- 2763- Two Channel Electrotherapy System
- 2786- Four Channel Electrotherapy System

### Optional Equipment

- 2780- Therapy System Cart (Unassembled)
- 2780ASY- Therapy System Cart (Assembled)
- 2767- NiMH Battery Module
- 27508 and 27079- User Remote Controls
- 2781- Channel 3/4 Electrotherapy Module



ISO 13485 CERTIFIED

Electromagnetic  
Compatibility (EMC)  
Tables

TOC





# TABLE OF CONTENTS

<b>FOREWORD</b> .....	<b>1</b>	<b>INTELECT LEGEND XT ELECTROTHERAPY AND COMBINATION THERAPY SYSTEMS</b> .....	<b>10</b>
▶ <b>PRODUCT DESCRIPTION</b> .....	1	Two Channel Electrotherapy System .....	10
<b>ABOUT INTELECT LEGEND XT</b> .....	<b>2</b>	Two Channel Combination System .....	10
▶ <b>STANDARD PRECAUTIONARY INSTRUCTIONS</b> .....	2	Front Access Panel .....	11
Caution .....	2	Rear Access Panel .....	11
Warning .....	2	▶ <b>USER INTERFACE</b> .....	<b>12</b>
Danger .....	2	▶ <b>SYMBOL DEFINITIONS</b> .....	<b>13</b>
Dangerous Voltage .....	2	System Hardware Symbols .....	13
Corrosive .....	2	System Software Symbols .....	13
Spontaneous Combustion .....	2	Optional Module and Accessory Symbols .....	13
Biohazardous Materials .....	2	Operator Remote .....	13
▶ <b>CAUTIONS</b> .....	3	Battery Module .....	13
▶ <b>WARNINGS</b> .....	4	Channel 3/4 Electrotherapy Module .....	13
▶ <b>DANGERS</b> .....	6	▶ <b>GENERAL TERMINOLOGY</b> .....	<b>14</b>
▶ <b>ELECTROTHERAPY INDICATIONS, CONTRAINDICATIONS, AND ADVERSE EFFECTS</b> .....	7	▶ <b>ULTRASOUND</b> .....	<b>14</b>
Indications for Russian, TENS, High Voltage Pulsed Current (HVPC), Interferential and Premodulated waveforms .....	7	<b>SPECIFICATIONS</b> .....	<b>15</b>
Additional Indications for Microcurrent, Interferential, Premodulated, and TENS waveforms .....	7	▶ <b>SYSTEM SPECIFICATIONS</b> .....	<b>15</b>
Contraindications .....	7	▶ <b>DIMENSIONS</b> .....	<b>15</b>
Additional Precautions .....	8	Width .....	15
Adverse Effects .....	8	Standard Weight .....	15
▶ <b>ULTRASOUND INDICATIONS AND CONTRAINDICATIONS</b> .....	9	Power (Combination and Electrotherapy Units) .....	15
Indications for Ultrasound .....	9	Electrical Type .....	15
Contraindications .....	9	Regulatory Compliance .....	15
Additional Precautions .....	9	▶ <b>WAVEFORM SPECIFICATIONS</b> .....	<b>16</b>
<b>NOMENCLATURE</b> .....	<b>10</b>	IFC- Interferential (Traditional 4 Pole) .....	16
		Russian .....	16
		TENS- Symmetrical Biphasic .....	17
		Microcurrent .....	17





# TABLE OF CONTENTS

Premodulated (Traditional 2 Pole IFC).....	18	▶ <b>ULTRASOUND PATIENT PREPARATION.....</b>	<b>31</b>
High Voltage Pulsed Current (HVPC).....	18	Preparing Treatment Area.....	31
▶ <b>ULTRASOUND SPECIFICATIONS.....</b>	<b>19</b>	Size of Applicator.....	31
Ultrasound.....	19	Applicator Preparation.....	31
▶ <b>SETUP.....</b>	<b>20</b>	Conductive Medium.....	31
▶ <b>INTELECT LEGEND XT THERAPY SYSTEMS.....</b>	<b>20</b>	Treatment Area.....	31
▶ <b>THERAPY SYSTEM SETUP.....</b>	<b>21</b>	Applicator LED.....	31
Clinic Name.....	21	▶ <b>OPERATION.....</b>	<b>32</b>
Restoring Default Protocols.....	22	▶ <b>OPERATOR INTERFACE.....</b>	<b>32</b>
Restoring Default Unit Settings.....	22	▶ <b>HOME SCREEN.....</b>	<b>33</b>
Erasing Patient Data Card.....	23	▶ <b>ELECTROTHERAPY SCREEN.....</b>	<b>34</b>
Setting Date and Time.....	23	▶ <b>GENERAL ELECTROTHERAPY WAVEFORM SETUP.....</b>	<b>35</b>
Setting System Volume.....	24	Prepare Patient.....	35
Displaying Unit Version Information.....	24	Select Modality.....	35
Pad Contact Quality.....	25	Select Waveform.....	35
Selecting Language.....	25	Edit Waveform Parameters.....	35
Connecting Accessories to the Therapy System.....	26	Installing Optional Patient Interrupt Switch.....	36
▶ <b>PATIENT PREPARATION.....</b>	<b>27</b>	Optional Patient Interrupt Switch.....	36
▶ <b>ELECTROTHERAPY PATIENT PREPARATION.....</b>	<b>27</b>	Setting Waveform Intensity.....	36
Electrode Placement.....	27	Intensity Knob Rotation.....	36
DURA-STICK™ Electrodes.....	28	Start Treatment.....	37
Reusable Carbon Electrodes (Optional).....	28	Pause Treatment.....	37
DURA-STICK™ Electrode Instructions.....	29	Stop Treatment.....	37
Connecting Lead Wires.....	29	Save to Patient Data Card.....	37
Securing Electrodes.....	29	▶ <b>ADJUSTING ELECTROTHERAPY CHANNEL PARAMETERS DURING TREATMENT.....</b>	<b>38</b>
Reusable Carbon Electrodes (Optional).....	30	Selecting Channel.....	38
Connecting Lead Wires.....	30	Editing Channel Parameters.....	38
Conductive Medium.....	30	▶ <b>ULTRASOUND.....</b>	<b>39</b>
Securing Electrodes.....	30		

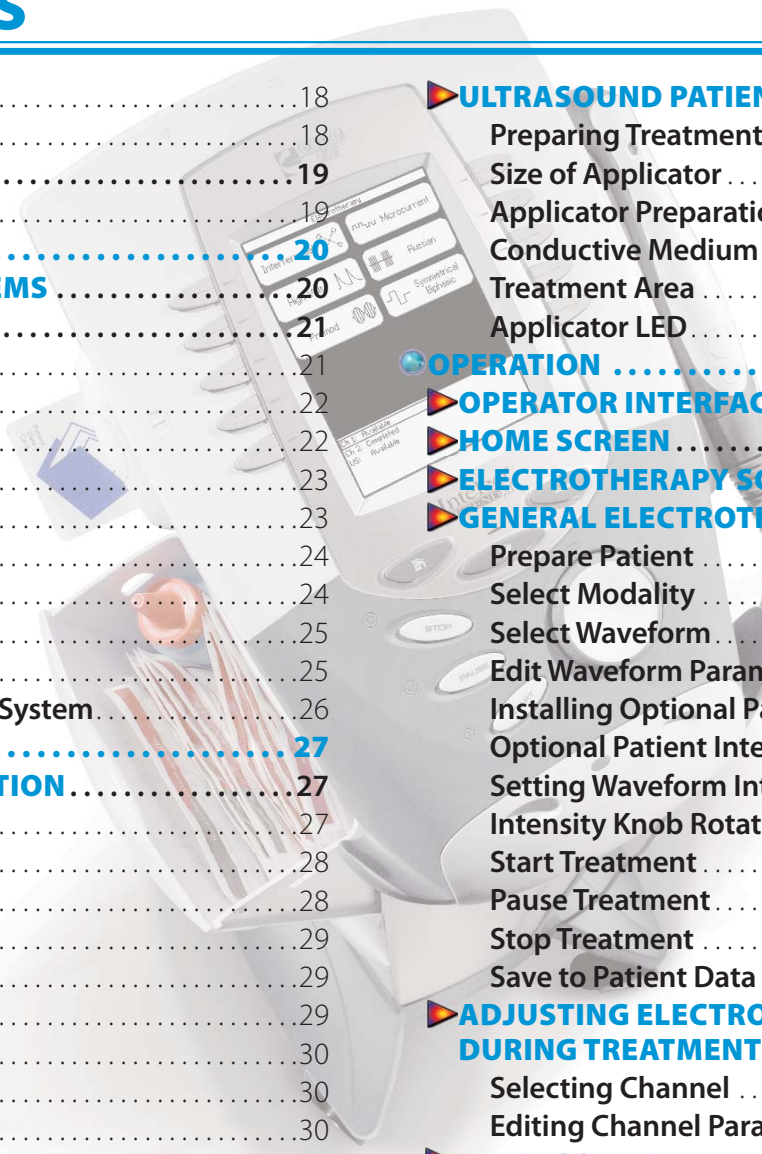





# TABLE OF CONTENTS

Preparing Patient .....	39	<b>▶ ADJUSTING COMBINATION PARAMETERS DURING TREATMENT .....</b>	<b>47</b>
Selecting Modality .....	39	Editing Waveform Parameters .....	47
Editing Ultrasound Parameters .....	39	Editing Ultrasound Parameters .....	47
Head Warming .....	39	<b>▶ PATIENT DATA CARD- SETTING UP A NEW CARD .....</b>	<b>48</b>
Setting Ultrasound Intensity .....	40	General Information .....	48
Intensity Knob Rotation .....	40	Inserting New Patient Data Card .....	48
Starting Treatment .....	40	Setting up Treatment .....	48
Pausing Treatment .....	40	Setting up a New Patient Data Card .....	48
Stopping Treatment .....	41	Entering Patient ID .....	49
Saving to Patient Data Card .....	41	Accessing Electrode Placement .....	50
Editing Ultrasound from Home Screen .....	42	Setting up Electrodes .....	50
Editing Ultrasound from Treatment Review Screen .....	42	Electrode Placement .....	50
<b>▶ COMBINATION .....</b>	<b>43</b>	Accessing Pain Map .....	51
Preparing Patient .....	43	Selecting Pain Type .....	51
Selecting Modality .....	43	Adding Pain Locations .....	51
Accessing Combination Parameters .....	43	Selecting Location of Pain .....	52
Editing Ultrasound Parameters .....	44	Editing Pain Locations .....	52
Selecting Waveform .....	44	Deleting Pain Locations .....	53
Using the Optional Patient Interrupt Switch .....	44	Pain Scales .....	53
Editing Waveform Parameters .....	45	Selecting Pain Scale .....	53
Setting Waveform Intensity .....	45	Adjusting Pain Scale .....	53
Intensity Knob Rotation .....	45	Saving to Patient Data Card .....	54
Setting Ultrasound Intensity .....	45	<b>▶ EXISTING PATIENT DATA CARD USE .....</b>	<b>55</b>
Intensity Knob Rotation .....	45	Inserting Existing Patient Data Card .....	55
Starting Treatment .....	46	Accessing Patient Data Card .....	55
Pausing Treatment .....	46	Viewing Patient Data Card .....	55
Stopping Treatment .....	46	Starting a New Treatment from Patient Data Card .....	56
Saving to Patient Data Card .....	46	Using the Optional Patient Interrupt Switch .....	56

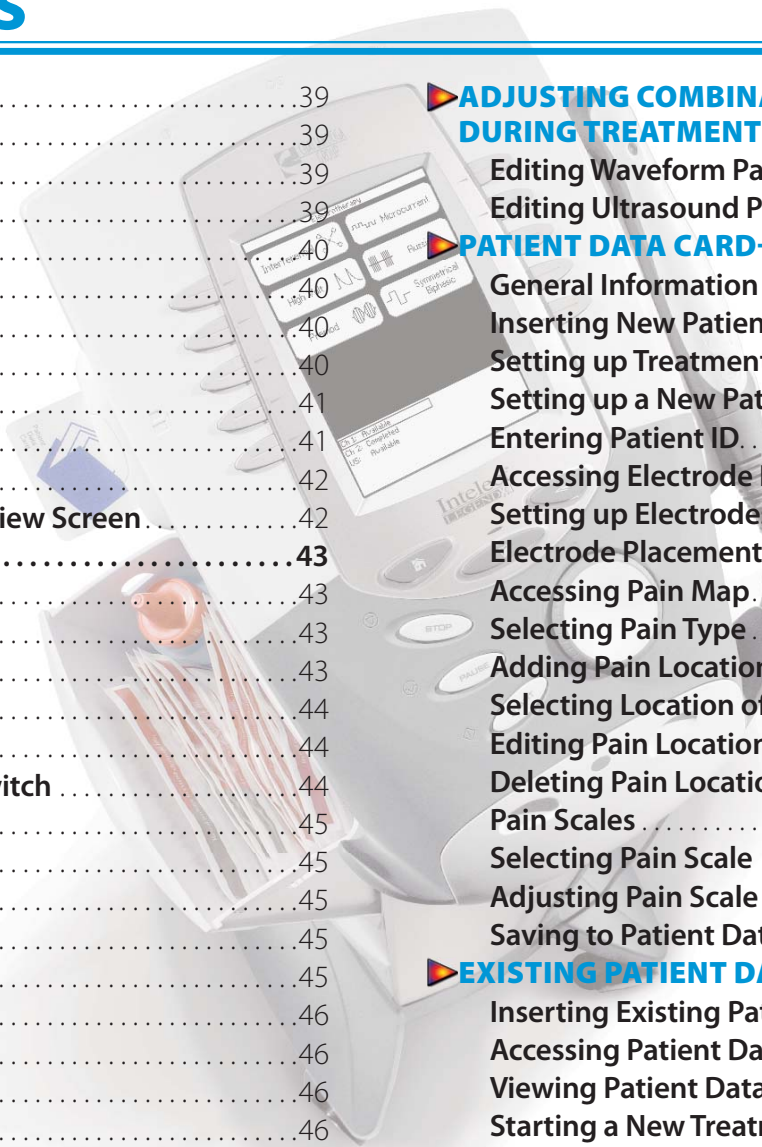



# TABLE OF CONTENTS

Setting Intensity .....	56	Saving to Patient Data Card .....	63
Intensity Knob Rotation .....	56	<b>INSTALLATION/REMOVAL .....</b>	<b>64</b>
Starting Treatment .....	57	<b>INSTALLING THE CHANNEL 3/4 ELECTROTHERAPY AND NiMH BATTERY MODULE .....</b>	<b>64</b>
Pausing Treatment .....	57	Nomenclature- Channel 3/4 Electrotherapy Module .....	65
Erasing Patient Data Card .....	57	Specifications .....	66
Stopping Treatment .....	57	Waveform & Current Specifications .....	66
<b>▶ CREATING USER PROTOCOLS .....</b>	<b>58</b>	Disconnecting Mains Power .....	67
General Information .....	58	Removing Lead Wires and Accessories .....	67
Selecting Modality .....	58	Removing Therapy System from Cart .....	67
Editing Modality Parameters .....	58	Releasing Ribbon Cable .....	68
Selecting Clinical Resources Library .....	58	Positioning Therapy System and Module .....	68
Entering User Protocol Name .....	59	Connecting Ribbon Cable .....	68
<b>▶ DELETING USER PROTOCOLS .....</b>	<b>60</b>	Setting Therapy System onto Module .....	69
General Information .....	60	Securing Therapy System to Module .....	69
Selecting Clinical Resources Library .....	60	Attaching the Lanyard .....	69
Selecting User Protocol to Delete .....	60	Installing Lead Wires and Accessories .....	70
Deleting User Protocol .....	60	Installing Front Access Panel .....	70
<b>▶ USING USER PROTOCOLS .....</b>	<b>61</b>	Mounting to Therapy System Cart .....	70
Accessing User Protocols .....	61	Connecting Mains Power .....	70
Selecting User Protocol .....	61	Turning Therapy System On .....	71
Preparing Patient .....	61	<b>▶ REMOVING THE CHANNEL 3/4 ELECTROTHERAPY AND NiMH BATTERY MODULE .....</b>	<b>72</b>
Editing Modality Parameters .....	61	Disconnecting Mains Power .....	72
Using the Optional Patient Interrupt Switch .....	62	Removing Lead Wires and Accessories .....	72
Setting Modality Intensity .....	62	Removing Therapy System from Cart .....	72
Intensity Knob Rotation .....	62	Removing Screws Securing Module .....	73
Starting Treatment .....	63	Disconnecting Ribbon Cable at Module .....	73
Pausing Treatment .....	63	Storing and Securing Ribbon Cable .....	73
Stopping Treatment .....	63		

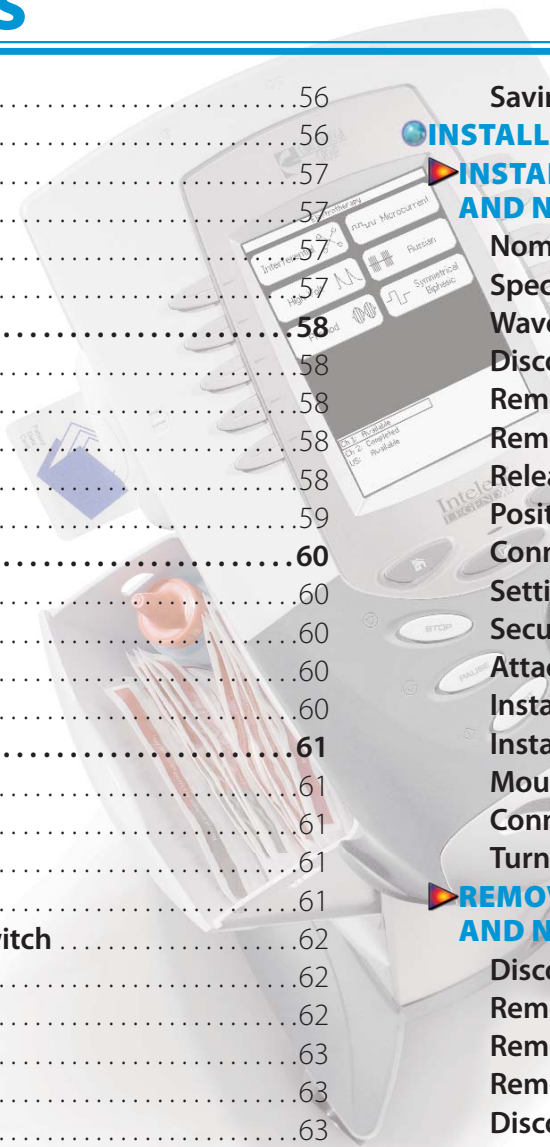



# TABLE OF CONTENTS

Attaching the Lanyard .....	74	Charging Temperature .....	84
Installing Lead Wires and Accessories .....	74	▶ <b>BATTERY MODULE SERVICE LIFE</b> .....	<b>85</b>
Connecting Mains Power .....	74	▶ <b>STORING THE BATTERY MODULE</b> .....	<b>85</b>
Turning Therapy System On .....	75	Short Term Storage .....	85
▶ <b>GENERAL INFORMATION- OPERATOR REMOTE</b> .....	<b>76</b>	Long Term Storage .....	85
Installing the Operator Remote .....	76	▶ <b>TROUBLESHOOTING</b> .....	<b>86</b>
▶ <b>GENERAL INFORMATION-THERAPY SYSTEM CART</b> .....	<b>77</b>	▶ <b>ERROR CODES</b> .....	<b>86</b>
Nomenclature .....	77	General Information .....	86
Specifications .....	77	▶ <b>REPLACEMENT ACCESSORIES</b> .....	<b>90</b>
▶ <b>MOUNTING THERAPY SYSTEM TO THERAPY SYSTEM CART</b> .....	<b>78</b>	▶ <b>GENERAL INFORMATION</b> .....	<b>90</b>
Assembling the Therapy System Cart .....	78	▶ <b>MAINTENANCE</b> .....	<b>91</b>
Preparing the Therapy System Cart .....	78	▶ <b>CARING FOR THE THERAPY SYSTEM</b> .....	<b>91</b>
Mounting Therapy System to Cart .....	78	Cleaning the Therapy System .....	91
Connecting Mains Power .....	79	Cleaning the Lens .....	91
Installing Storage Bins .....	79	▶ <b>CALIBRATION REQUIREMENTS</b> .....	<b>91</b>
Removing System from Therapy System Cart .....	79	Calibrating Ultrasound Applicators .....	91
▶ <b>OPTION OPERATION</b> .....	<b>80</b>	▶ <b>FACTORY SERVICE</b> .....	<b>91</b>
▶ <b>USING THE OPERATOR REMOTE</b> .....	<b>80</b>	▶ <b>WARRANTY</b> .....	<b>92</b>
Nomenclature .....	80		
Operation .....	80		
Storing the Operator Remote .....	81		
▶ <b>USING THE THERAPY SYSTEM CART</b> .....	<b>82</b>		
Nomenclature .....	82		
Operation .....	82		
▶ <b>USING THE NiMH BATTERY MODULE</b> .....	<b>83</b>		
Nomenclature .....	83		
▶ <b>CHARGING BATTERY MODULE</b> .....	<b>84</b>		
When to Recharge .....	84		





# FOREWORD

This manual has been written for the users of the Intellect Legend XT® Therapy Systems. It contains general information on the operation, precautionary practices, and maintenance information. In order to maximize use, efficiency, and the life of the system, please read this manual thoroughly and become familiar with the controls, as well as the accessories before operating the system.

This manual contains general safety, operating, maintenance, and care instructions as well as installation instructions for the optional Therapy System Cart, Channel 3/4 Electrotherapy and NiMH Battery for the users of the Intellect Legend XT Therapy two channel electrotherapy and combination systems.

Specifications put forth in this manual were in effect at the time of publication. However, owing to Chattanooga Group's policy of continual improvement, changes to these specifications may be made at any time without obligation on the part of Chattanooga Group. Before administering any treatment to a patient, the users of this equipment should read, understand and follow the information contained in this manual for each mode of treatment available, as well as the indications, contraindications, warnings and precautions. Consult other resources for additional information regarding the application of electrotherapy and ultrasound.

## PRODUCT DESCRIPTION

The Intellect Legend XT Therapy Systems are two channel electrotherapy and combination systems with the option of adding additional channels of electrotherapy by installation of the optional Channel 3/4 Electrotherapy Module. Other optional modality modules are available for separate purchase and may be installed by the end user.

Stay current with the latest clinical developments in the field of electrotherapy and ultrasound. Observe all applicable precautionary measures for treatment.

Keep informed of appropriate indications and contraindications for the use of electrotherapy and ultrasound.

**This equipment is to be used only under the prescription and supervision of a licensed practitioner.**







# ABOUT INTELECT LEGEND XT

## STANDARD PRECAUTIONARY INSTRUCTIONS

The precautionary instructions found in this section and throughout this manual are indicated by specific symbols. Understand these symbols and their definitions before operating this equipment. The definition of these symbols are as follows:



### Caution

Text with a "CAUTION" indicator will explain possible safety infractions that could have the potential to cause minor to moderate injury or damage to equipment.



### Warning

Text with a "WARNING" indicator will explain possible safety infractions that will potentially cause serious injury and equipment damage.



### Danger

Text with a "DANGER" indicator will explain possible safety infractions that are imminently hazardous situations that would result in death or serious injury.



### Dangerous Voltage

Text with a "Dangerous Voltage" indicator serves to inform the user of possible hazards resulting in the electrical charge delivered to the patient in certain treatment configurations of TENS waveforms.



### Corrosive

Text with a "CORROSIVE" indicator will explain possible safety infractions if the chemical components of the battery are exposed to air, skin, or other materials.



### Spontaneous Combustion

Text with a "SPONTANEOUS COMBUSTION" indicator will explain possible safety infractions that could create conditions for a Spontaneous Combustion if the material is mishandled and not disposed of properly.



### Biohazardous Materials

Text with a "BIOHAZARD" indicator serves to inform the user of possible hazards resulting in improper handling of components and accessories that have come in contact with bodily fluids.

**NOTE:** Throughout this manual, "NOTE" may be found. These Notes are helpful information to aid in the particular area or function being described.





## CAUTION

- Read, understand, and practice the precautionary and operating instructions. Know the limitations and hazards associated with using any electrical stimulation or ultrasound device. Observe the precautionary and operational decals placed on the unit.
- DO NOT operate the Intelect Legend XT Therapy System when connected to any unit other than Chattanooga Group devices.
- DO NOT operate this unit in an environment where other devices are being used that intentionally radiate electromagnetic energy in an unshielded manner.
- Ultrasound should be routinely checked before each use to determine that all controls function normally, especially that the intensity control does properly adjust the intensity of the ultrasonic power output in a stable manner. Also, determine that the treatment time control does actually terminate ultrasonic power output when the timer reaches zero.
- DO NOT use sharp objects such as a pencil point or ballpoint pen to operate the buttons on the control panel.
- This unit should be operated, transported and stored in temperatures between 59 °F and 104 °F (15 °C and 40 °C), with Relative Humidity ranging from 30%-60%.
- Handle Ultrasound Applicator with care. Inappropriate handling of the Ultrasound Applicator may adversely affect its characteristics.
- Before each use, inspect Ultrasound Applicator for cracks, which may allow the ingress of conductive fluid.

## CAUTION

- Inspect Applicator cables and associated connectors before each use.
- The Intelect Legend XT Therapy System is not designed to prevent the ingress of water or liquids. Ingress of water or liquids could cause malfunction of internal components of the system and therefore create a risk of injury to the patient.
- This equipment generates, uses and can radiate radio frequency energy and, if not installed and used in accordance with the instructions, may cause harmful interference to other devices in the vicinity. However, there is no guarantee that interference will not occur in a particular installation. Harmful interference to other devices can be determined by turning this equipment on and off. Try to correct the interference using one or more of the following: reorient or relocate the receiving device, increase the separation between the equipment, connect the equipment to an outlet on a different circuit from that to which the other device(s) are connected and consult the factory field service technician for help.
- The Nylatex® Wraps contain dry natural rubber and may cause allergic reactions in patients with allergies to latex.



## WARNING

- U.S.A. Federal Law restricts these devices to sale by, or on the order of, a physician or licensed practitioner. This device should be used only under the continued supervision of a physician or licensed practitioner.
- Make certain the unit is electrically grounded by connecting only to a grounded electrical service receptacle conforming to the applicable national and local electrical codes.
- Care must be taken when operating this equipment around other equipment. Potential electromagnetic or other interference could occur to this or to the other equipment. Try to minimize this interference by not using other equipment in conjunction with it.
- The safety of TENS waveforms for use during pregnancy or birth has not been established.
- TENS is not effective for pain of central origin. (This includes headache)
- TENS should be used only under the continued supervision of a physician or licensed practitioner.
- TENS waveforms have no curative value.
- TENS is a symptomatic treatment, and as such, suppresses the sensation of pain which would otherwise serve as a protective mechanism.
- The user must keep the device out of the reach of children.
- Electronic monitoring equipment (such as ECG monitors and ECG alarms) may not operate properly when TENS stimulation is in use.
- Powered muscle stimulators should be used only with the leads and electrodes recommended for use by the manufacturer.



## WARNING

- In the event that an Error message or Warning appears beginning with a 2 or 3, immediately stop all use of the system and contact the dealer or Chattanooga Group for service. Errors and Warnings in these categories indicate an internal problem with the system that must be tested by Chattanooga Group or a Field Service Technician certified by Chattanooga Group before any further operation or use of the system. Use of a system that indicates an Error or Warning in these categories may pose a risk of injury to the patient, user or cause extensive internal damage to the system.
- Use of controls or adjustments or performance of procedures other than those specified herein may result in hazardous exposure to ultrasonic energy.
- Before administering any treatment to a patient you should become acquainted with the operating procedures for each mode of treatment available, as well as the indications, contraindications, warnings, and precautions. Consult other resources for additional information regarding the application of Electrotherapy and Ultrasound.
- To prevent electrical shock, disconnect the unit from the power source before attempting any maintenance procedures.
- Keep electrodes separated during treatment. Electrodes in contact with each other could result in improper stimulation or skin burns.
- Long term effects of chronic electrical stimulation are unknown.





# ABOUT INTELECT LEGEND XT



## WARNING

- Stimulation should not be applied over the anterior neck or mouth. Severe spasm of the laryngeal and pharyngeal muscles may occur and the contractions may be strong enough to close the airway or cause difficulty in breathing.
- Stimulation should not be applied transthoracically in that the introduction of electrical current into the heart may cause cardiac arrhythmia.
- Stimulation should not be applied over swollen, infected, and inflamed areas or skin eruptions, e.g., phlebitis, thrombophlebitis, varicose veins, etc.
- Stimulation should not be applied over, or in proximity to, cancerous lesions.
- Output current density is related to electrode size. Improper application may result in patient injury. If any question arises as to the proper electrode size, consult a licensed practitioner prior to therapy session.
- The Intelect Legend XT Therapy System optional modules and associated accessories are designed for use only with the Chattanooga Group Intelect Legend XT Electrotherapy and Combination Therapy Systems.







## DANGERS

### DANGER



- Stimulus delivered by the TENS waveforms of this device, in certain configurations, will deliver a charge of 25 microcoulombs ( $\mu\text{C}$ ) or greater per pulse and may be sufficient to cause electrocution. Electrical current of this magnitude must not flow through the thorax because it may cause a cardiac arrhythmia.
- Patients with an implanted neurostimulation device must not be treated with or be in close proximity to any shortwave diathermy, microwave diathermy, therapeutic ultrasound diathermy, or laser diathermy anywhere on their body. Energy from diathermy (shortwave, microwave, ultrasound, and laser) can be transferred through the implanted neurostimulation system, can cause tissue damage, and can result in severe injury or death. Injury, damage, or death can occur during diathermy therapy even if the implanted neurostimulation system is turned "off."
- Handle, clean, and dispose of components and accessories that have come in contact with bodily fluids according to National, Local and Facility rules, regulations and procedures.



### DANGER



- NiMH Batteries contain Class E Corrosive materials. In the event of battery cell rupture or leakage, handle Battery Module wearing neoprene or natural rubber gloves. Contents of a ruptured or leaking battery can cause respiratory irritation. Hypersensitivity to nickel can cause allergic pulmonary asthma. Contents of cell coming in contact with skin can cause skin irritation and/or chemical burns.



- Never, under any circumstances, open the Battery Module housing or cells. Should an individual cell from a battery become disassembled, spontaneous combustion of the negative electrode is possible. There can be a delay between exposure to air and spontaneous combustion.
- Charge the Battery Module according to the instructions found in this manual. Never attempt to charge the Battery Module on any other charging mechanism.
- Use the Battery Module only with the Intelect Legend XT Therapy Systems.
- Do not reverse the polarity of the Battery Module. Doing so can increase the individual cell temperature and cause cell rupture or leakage.
- Never dispose of Battery Module in fire. Never short circuit the battery. The battery may explode, ignite, leak or get hot causing serious personal injury.
- Dispose of NiMH batteries according to national, state and local codes and regulations.



# ABOUT INTELECT LEGEND XT

## ELECTROTHERAPY INDICATIONS, CONTRAINDICATIONS, AND ADVERSE EFFECTS

### Indications for Russian, TENS, High Voltage Pulsed Current (HVPC), Interferential and Premodulated waveforms

- Relaxation of muscle spasms
- Prevention or retardation of disuse atrophy
- Increase local blood circulation
- Muscle re-education
- Maintaining or increasing range of motion

### Additional Indications for Microcurrent, Interferential, Premodulated, and TENS waveforms

- Symptomatic relief and management of chronic, intractable pain
- Post-traumatic acute pain
- Post-surgical acute pain

### Contraindications

- This device should not be used for symptomatic local pain relief unless etiology is established or unless a pain syndrome has been diagnosed.
- This device should not be used when cancerous lesions are present in the treatment area.
- Stimulation should not be applied over swollen, infected, inflamed areas or skin eruptions (e.g. phlebitis, thrombophlebitis, varicose veins, etc.).
- Other contraindications are patients suspected of carrying serious infectious disease and or disease where it is advisable, for general medical purposes, to suppress heat or fevers.
- Electrode placements must be avoided that apply current to the carotid sinus region (anterior neck) or transcerebrally (through the head).
- Safety has not been established for the use of therapeutic electrical stimulation during pregnancy.
- Powered muscle stimulators should not be used on patients with cardiac demand pacemakers.
- There should not be any use of TENS waveforms on patients with cardiac demand pacemakers.





# ABOUT INTELECT LEGEND XT

## ELECTROTHERAPY INDICATIONS, CONTRAINDICATIONS, AND ADVERSE EFFECTS (CONTINUED)

### Additional Precautions

- Caution should be used for patients with suspected or diagnosed heart problems.
- Caution should be used for patients with suspected or diagnosed epilepsy.
- Caution should be used in the presence of the following:
  - When there is a tendency to hemorrhage following acute trauma or fracture.
  - Following recent surgical procedures when muscle contraction may disrupt the healing process.
  - Over a menstruating or pregnant uterus.
  - Over areas of the skin which lack normal sensation.
- Some patients may experience skin irritation or hypersensitivity due to the electrical stimulation or electrical conductive medium. The irritation can usually be reduced by using an alternative conductive medium or an alternative electrode placement.
- Electrode placement and stimulation settings should be based on the guidance of the prescribing practitioner.
- Powered muscle stimulators should be used only with the lead wires and electrodes recommended for use by the manufacturer.

- With TENS waveforms, isolated cases of skin irritation may occur at the site of electrode placement following long-term application.
- The effectiveness of TENS waveforms is highly dependent upon patient selection by a person qualified in pain management.

### Adverse Effects

- Skin irritation and burns beneath the electrodes have been reported with the use of powered muscle stimulators.
- Potential adverse effects with TENS are skin irritation and electrode burns.







# ABOUT INTELECT LEGEND XT

## ULTRASOUND INDICATIONS AND CONTRAINDICATIONS

### Indications for Ultrasound

Application of therapeutic deep heat for the treatment of selected sub-chronic and chronic medical conditions such as:

- Relief of pain, muscle spasms, and joint contractures
- Relief of pain, muscle spasms, and joint contractures that may be associated with:
  - Adhesive capsulitis
  - Bursitis with slight calcification
  - Myositis
  - Soft tissue injuries
  - Shortened tendons due to past injuries and scar tissues
- Relief of sub-chronic, chronic pain, and joint contractures resulting from:
  - Capsular tightness
  - Capsular scarring

### Contraindications

- This device should not be used for symptomatic local pain relief unless etiology is established or unless a pain syndrome has been diagnosed.
- This device should not be used when cancerous lesions are present in the treatment area.
- Other contraindications are patients suspected of carrying serious infectious disease and disease where it is advisable for general medical purposes to suppress heat or fevers.

- This device should not be used over or near bone growth centers until bone growth is complete.
- This device should not be used over the thoracic area if the patient is using a cardiac pacemaker.
- This device should not be used over a healing fracture.
- This device should not be used over or applied to the eye.
- This device should not be used over a pregnant uterus.
- This device should not be used on ischemic tissues in individuals with vascular disease where the blood supply would be unable to follow the increase in metabolic demand and tissue necrosis might result.

### Additional Precautions

Additional precautions should be used when ultrasound is used on patients with the following conditions:

- Over an area of the spinal cord following a Laminectomy, i.e., when major covering tissues have been removed
- Over anesthetic areas
- On patients with hemorrhagic diatheses



# NOMENCLATURE

## INTELECT LEGEND XT ELECTROTHERAPY AND COMBINATION THERAPY SYSTEMS

### Two Channel Electrotherapy System



- 1. Two Channel Electrotherapy System
- 2. User Interface **(See Page 12)**
- 3. Front Access Panel
- 4. Rear Access Panel
- 5. Patient Data Card access port
- 6. Multimedia Card (MMC) access port (Unused)

### Two Channel Combination System



- 1. Two Channel Combination System
- 2. User Interface **(See Page 12)**
- 3. Front Access Panel
- 4. Rear Access Panel
- 5. Patient Data Card access port
- 6. Multimedia Card (MMC) access port (Unused)
- 7. Ultrasound Applicator (5cm<sup>2</sup> shown)

# NOMENCLATURE

## INTELECT LEGEND XT ELECTROTHERAPY AND COMBINATION THERAPY SYSTEMS (CONTINUED)

### Front Access Panel



1. Front Access Panel Lanyard  
When reinstalling the Front Access Panel, make certain the Lanyard does not become kinked.
2. Operator Remote Control Connector
3. Patient Interrupt Switch Connector
4. Channel 1 Lead Wire Connector
5. Channel 2 Lead Wire Connector
6. Microcurrent Probe Connector
7. Ultrasound Applicator Connector

### Rear Access Panel

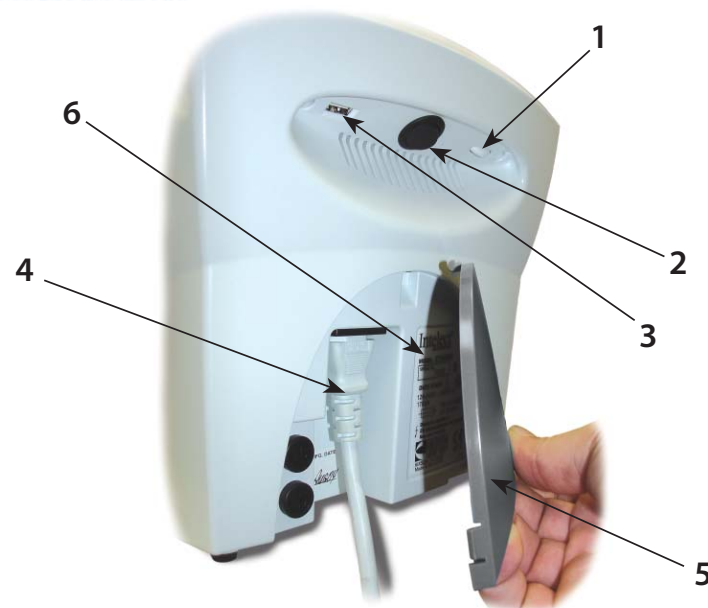

1. Screen Contrast Control
2. Power On/Off Switch
3. Technical Maintenance Port
4. Mains Power Cord
5. Rear Access Panel
6. Serial Decal





# NOMENCLATURE

## USER INTERFACE

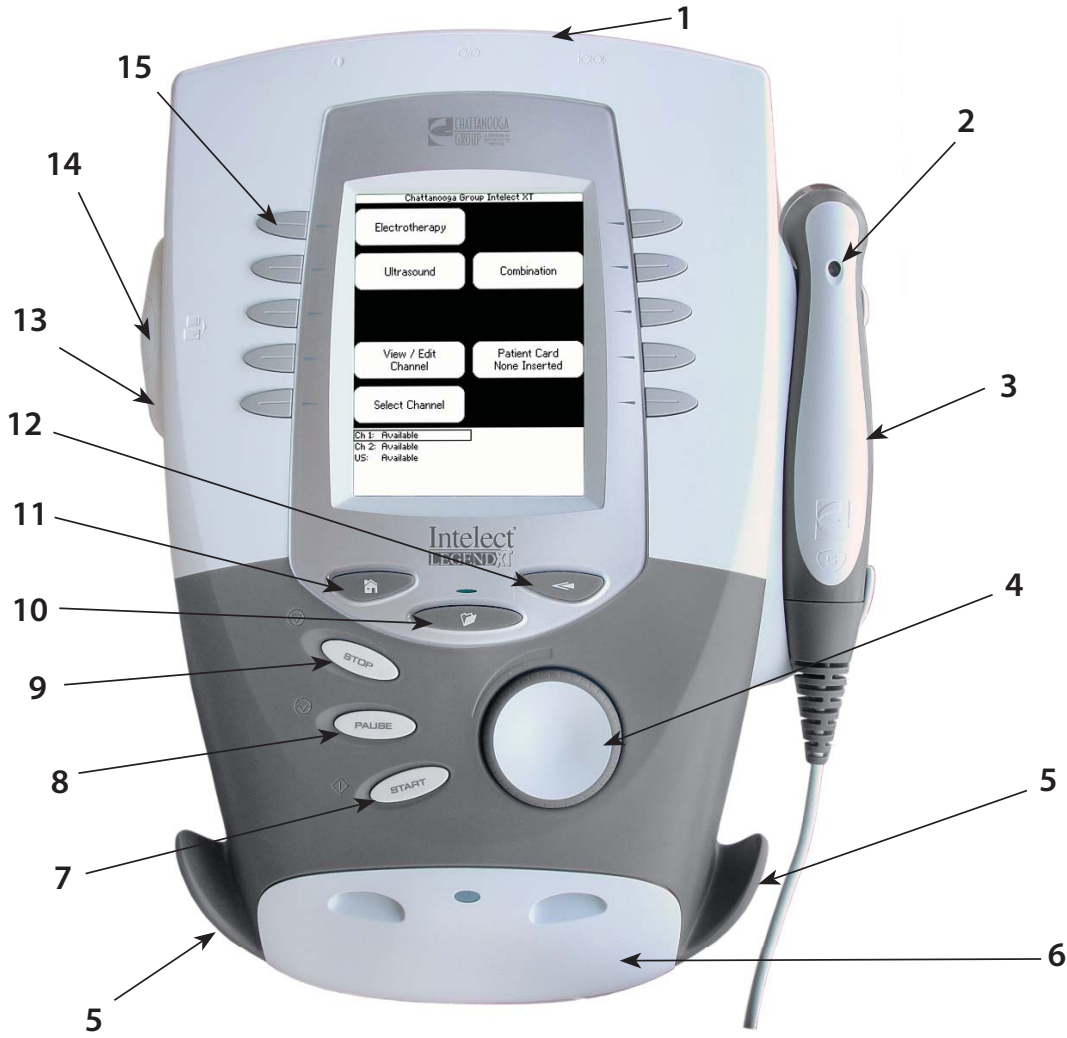

1. Rear Access Panel (**See Page 11**)
2. Ultrasound Applicator LED Indicator (Combination only)
3. Ultrasound Applicator- 5 cm<sup>2</sup> Standard (Optional 1 cm<sup>2</sup>, 2 cm<sup>2</sup>, and 10 cm<sup>2</sup> applicators available, Combination only)
4. Intensity knob
5. Cable and Lead Wire Hook
6. Front Access Panel (**See Page 11**)
7. Start button
8. Pause button
9. Stop button
10. Clinical Resources Library button
11. Home Screen button
12. Back button
13. Patient Data Card Port
14. Multimedia Card (MMC) Port (Unused)
15. User Setup and Parameter Control buttons





## SYMBOL DEFINITIONS

Below are the definitions for all of the symbols used in the Intellect Legend XT hardware and software. Study and learn these symbols before any operation of the system.

### System Hardware Symbols

	CONTRAST CONTROL		THERAPY INTENSITY CONTROL		PATIENT INTERRUPT SWITCH
	ON/OFF SWITCH		HOME		CHANNEL 1 LEAD WIRES
	DATA PORT		CLINICAL RESOURCES LIBRARY		CHANNEL 2 LEAD WIRES
	MULTIMEDIA CARD*		BACK		MICROCURRENT PROBE
	PATIENT DATA CARD		CHANNEL 1/2 OPERATOR REMOTE CONTROL (OPTIONAL)		ULTRASOUND APPLICATOR
	STOP TREATMENT				
	PAUSE TREATMENT				
	START TREATMENT				

\* Used for System Software Upgrades

### System Software Symbols

	MOVE UP
	MOVE DOWN
	MOVE RIGHT
	MOVE LEFT
	ACCEPT AND RETURN
	DO NOT ACCEPT AND RETURN
	PAD CONTACT QUALITY (SINGLE CHANNEL GRAPH)
	PAD CONTACT QUALITY (DUAL CHANNEL GRAPH)

### Optional Module and Accessory Symbols

#### Operator Remote

	INCREASE INTENSITY
	DECREASE INTENSITY
	PAUSE TREATMENT
	MANUAL STIMULATION

#### Battery Module

	CHARGE LEVEL
	BATTERY CHARGING

#### Channel 3/4 Electrotherapy Module

	PATIENT INTERRUPT SWITCH
	CHANNEL 3 LEAD WIRES
	CHANNEL 4 LEAD WIRES
	MICROCURRENT PROBE
	CHANNEL 3/4 OPERATOR REMOTE CONTROL (OPTIONAL)



# NOMENCLATURE

## GENERAL TERMINOLOGY

Below are the definitions for all of the unique terminology used throughout this manual. Study these and become familiar with these terms for ease of system operation and familiarization with the components and control functionality of the Intellect Legend XT Therapy System. Some of these terms and definitions refer to a specific button or control on the system. **Refer to page 13** for Symbol Definitions.

### Back button

The dedicated button on the Main unit, below the display, that each time pressed takes the user back one screen at a time.

### Previous Page button

The button used in some modalities and functions that will take the user back one page when reading multiple pages of text.

### UP and DOWN Arrows

Controls used in various modality parameter screens to navigate or change a value up or down within the parameter.

### Electrotherapy

Refers to the Electrical muscle or nerve Stimulation modalities of the system.

### System

The primary system with all controls and functions.

### Module

Any optional modular modality component designed for installation onto the System.

## ULTRASOUND



### 1. Sound Head

That component of the Applicator that makes contact with the patient during Ultrasound or Combination therapy.

### 2. Applicator

The assembly that connects to the System and incorporates the Sound Head.

### 3. Applicator LED

The component of the Applicator which, when illuminated, indicates if the Sound Head is emitting Ultrasound.

# SPECIFICATIONS



## SYSTEM SPECIFICATIONS



**NOTE:** All waveforms except High Voltage Pulsed Current (HVPC) have been designed with a 200 mA current limit. TENS waveform output intensities are measured, specified and listed to peak, not peak to peak.

## DIMENSIONS

### Width

- Combination System ..... 11.375 in (28.9 cm)
- Electrotherapy System ..... 9.750 in (24.8 cm)

**Depth** (Combination and Electrotherapy System) . 12.750 in (32.4 cm)

**Height** (Combination and Electrotherapy System) . 8.750 in (22.2 cm)

### Standard Weight

- Two Channel Combination System..... 7 lbs (3.2 kg)
- Two Channel Electrotherapy System ..... 6 lbs (2.7 kg)

### Power (Combination and Electrotherapy Units)

- Input ..... 100 - 240 V - 1.0 A, 50/60 Hz
- Output (Internal Power Supply)..... +24 V, 7.3 A
- Electrical Class ..... CLASS I

### Electrical Type

- Ultrasound ..... TYPE B 
- Electrotherapy and sEMG ..... TYPE BF 

### Regulatory Compliance

- UL/IEC/EN 60601-1
- IEC/EN 60601-1-2
- IEC 60601-2-5
- IEC 60601-2-10





# SPECIFICATIONS

## WAVEFORM SPECIFICATIONS



### IFC- Interferential (Traditional 4 Pole)

Interferential Current is a medium frequency waveform. Current is distributed through two channels (four electrodes). The currents cross each other in the body at the area requiring treatment. The two currents interfere with each other at this crossing point, resulting in a modulation of the intensity (the current intensity increases and decreases at a regular frequency).

Output Mode.....	Electrodes
Carrier Frequency.....	2,500-5,000 Hz
Beat Frequency.....	1-200 Hz
Sweep Time.....	15 sec
Sweep Low Beat Frequency.....	1-200 Hz
Sweep High Beat Frequency.....	1-200 Hz
Scan Percentage.....	Static, 10%, 40%, 100%
Amplitude.....	0-100 mA Peak into 500 ohm
Treatment Time.....	1-60 minutes
Available on Channel.....	1 & 2, 3 & 4 Option

\*CC= Constant Current  
CV= Constant Voltage

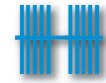

### Russian

Russian Current is a sinusoidal waveform, delivered in bursts or series of pulses. This method was claimed by its author (Kots) to produce maximal muscle strengthening effects without significant discomfort to the patient.

Output Mode.....	Electrodes
Output Intensity.....	0-100 mA
Channel Mode.....	Single, Reciprocal, Co-Contract
Duty Cycle.....	10%, 20%, 30%, 40%, 50%
Mode Selection.....	CC or CV*
Anti-Fatigue.....	Off or On
Cycle Time.....	.5/5, 4/12, 10/10, 10/20, 10/30, 10/50, Continuous
Burst Frequency (Anti-Fatigue Off).....	20-100 bps
Ramp.....	0.5, 1, 2, and 5 sec
Treatment Time.....	1-60 minutes
Available on Channels.....	1 & 2, 3 & 4 Option







# SPECIFICATIONS

## WAVEFORM SPECIFICATIONS (CONTINUED)

### TENS- Symmetrical Biphasic

The Symmetrical Biphasic waveform has a short pulse duration and is capable of strong stimulation of nerve fibers in the skin and in muscle. This waveform is often used in portable muscle stimulation units, and some TENS devices. Because of its short pulse duration, the patient typically tolerates the current well, even at relatively high intensities.

- Output Mode.....Electrodes
- Output Intensity.....0-80 mA
- Phase Duration.....Adjustable 20-1,000  $\mu$ sec
- Frequency..... 1-250 Hz
- Mode Selection..... CC or CV\*
- Burst Frequency..... 0-25 bps
- Frequency Modulation..... 0-250 Hz
- Amplitude Modulation.....Off, 40%, 60%, 80%, and 100%
- Treatment Time..... 1-60 minutes

\*CC= Constant Current  
CV= Constant Voltage

### Microcurrent

Microcurrent is a monophasic waveform of very low intensity that closely simulates the electrical current generated by the human body. Microcurrent can be applied via electrodes or probe.

- Output Mode..... Electrodes or Probe
- Output Intensity.....0-1000  $\mu$ A
- Polarity..... Positive, Negative, or Alternating
- Treatment Time..... 1-60 minutes
- Available on channels..... 1 & 2, 3, & 4 Option

 **DANGER**



Stimulus delivered by the TENS waveforms of this device, in certain configurations, will deliver a charge of 25 microcoulombs ( $\mu$ C) or greater per pulse and may be sufficient to cause electrocution. Electrical current of this magnitude must not flow through the thorax because it may cause a cardiac arrhythmia.





# SPECIFICATIONS

## WAVEFORM SPECIFICATIONS (CONTINUED)



### Premodulated (Traditional 2 Pole IFC)

Premodulated Current is a medium frequency waveform. Current comes out of one channel (two electrodes). The current intensity is modulated: it increases and decreases at a regular frequency (the Amplitude Modulation Frequency).

Output Mode.....	Electrodes
Output Intensity.....	0-100 mA
Carrier Frequency.....	2,500 Hz
Beat Fixed (Sweep Off) .....	1-200 Hz
Sweep Low Beat Frequency .....	1-200 Hz
Sweep High Beat Frequency.....	81-200 Hz
Cycle Time.....	Continuous, 5/5, 4/12, 10/10, 10/20, 10/30, 10/50
Mode Selection .....	CC or CV*
Treatment Time.....	1-60 minutes
Available on Channel.....	1 & 2, 3, & 4 Option

\*CC= Constant Current  
CV= Constant Voltage



### High Voltage Pulsed Current (HVPC)

The High Voltage Pulsed Current (HVPC) has a very brief pulse duration characterized by two distinct peaks delivered at high voltage. The waveform is monophasic (current flows in one direction only). The high voltage causes a decreased skin resistance making the current comfortable and easy to tolerate.

Output Mode.....	Electrodes or Probe
Output Intensity.....	0-500 V
Polarity .....	Positive or Negative
Ramp.....	0.5 sec, 1 sec, 2 sec, 5 sec
Display .....	Peak Current or Volts
Sweep.....	Continuous, 80/120 pps, 1/120 pps, 1/10 pps
Frequency.....	10-120 pps
Cycle Time.....	5/5, 4/12, 10/10, 10/20, 10/30, 10/50, Continuous
Treatment Time.....	1-60 minutes
Available on Channels.....	1 & 2, 3, & 4 Option



# SPECIFICATIONS



## ULTRASOUND SPECIFICATIONS



### Ultrasound

Frequency.....1 MHz, ± 5%; 3.3 Mhz, ±5%  
 Duty Cycles..... 10%, 20%, 50%, Continuous  
 Pulse Frequency..... 100 Hz  
 Pulse Duration..... 1 mSec, ±20%; 2 mSec, ±20%; 5 mSec, ±20%

### Output Power

10 cm<sup>2</sup> Crystal .....0-20 W at 1 MHz, 0-10 W at 3.3 MHz  
 5 cm<sup>2</sup> Crystal .....0-10 W, 1 and 3.3 MHz  
 2 cm<sup>2</sup> Crystal .....0-4 W, 1 and 3.3 MHz  
 1 cm<sup>2</sup> Crystal ..... 0-2 W 3.3 MHz Only

Amplitude.....0 to 2.5 w/cm<sup>2</sup> in continuous mode,  
 0-3 w/cm<sup>2</sup> in pulsed modes

Output accuracy.....±20% above 10% of maximum  
 Temporal Peak to Average Ratio: ... 2:1, ± 20%, at 50% Duty Cycle  
 5:1, ± 20%, at 20% Duty Cycle  
 9:1, ± 20%, at 10% Duty Cycle

Beam Nonuniformity Ratio..... 5.0 : 1 maximum  
 Beam Type .....Collimating

Effective Radiating Areas..... 10 cm<sup>2</sup> Crystal: 6.8 cm<sup>2</sup> – 10 cm<sup>2</sup>  
 5 cm<sup>2</sup> Crystal: 3.5 cm<sup>2</sup> – 5 cm<sup>2</sup>  
 2 cm<sup>2</sup> Crystal: 1.4 cm<sup>2</sup> – 2 cm<sup>2</sup>  
 1 cm<sup>2</sup> Crystal: 0.7 cm<sup>2</sup> – 1 cm<sup>2</sup>

Treatment Time.....1-30 minutes

### Head Warming Feature

The Head Warming feature of an Intellect Legend XT Combination Therapy System utilizes Ultrasound output resulting in warming of the Sound Head to increase patient comfort.

With Head Warming enabled, ultrasound is emitted without pressing the Start button. The Applicator LED will not illuminate during the Head Warming period. US Channel will indicate "Head Warming".

Output .....0 - 50% Cycling of maximum power  
 Frequency..... 3.3 Mhz  
 Sound Head Temperature ..... 85 °F - 110 °F (29.4 °C - 43.3 °C)

WARNING

Do not apply the Ultrasound Applicator to the patient during the Head Warming period. Applicator must remain in Applicator Hook during the Head Warming period.





# SETUP

## INTELECT LEGEND XT THERAPY SYSTEMS

Remove the Intellect Legend XT Two or Four Channel Therapy System and all accessories from the shipping carton. Visually inspect for damage. Report any damage to the carrier immediately.

### Contents of Carton:

- Intellect Legend XT Two or Four Channel Electrotherapy or Combination System
- Patient Data Cards (1)
- Electrotherapy Lead Kit that includes:
  - Lead Wires (one for Channel 1 and one for Channel 2)
  - DURA-STICK™ II 2.75 in (7 cm) Round Disposable Electrodes (1 pack of 4)
- Lead Wires- (one for Channel 3 and one for Channel 4 - Four Channel Systems only)
- 5 cm<sup>2</sup> Ultrasound Applicator (Combination Systems Only)
- Cord Set
- Conductor Transmission Gel - 1 bottle (Combination Systems Only)
- User Manual





# SETUP

## THERAPY SYSTEM SETUP

### Accessing Operator Utilities

Plug unit into wall outlet.

Turn system On.



Press the Home and Back buttons simultaneously.

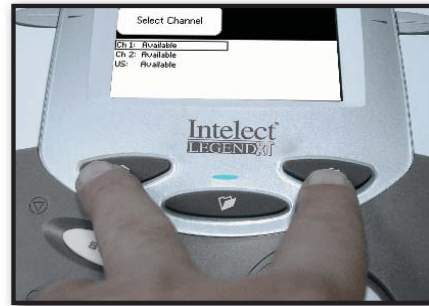

To return to the System Home screen, press the Home button.

### Clinic Name

Press Clinic Name button.

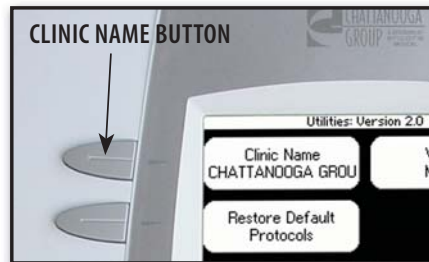

Select the row of alpha or numeric characters desired by pushing the button beside the corresponding row. Select the desired character in the row by pressing the row button until the desired letter is framed.

**NOTE:** To add a space, select the area to the left of the letter A.

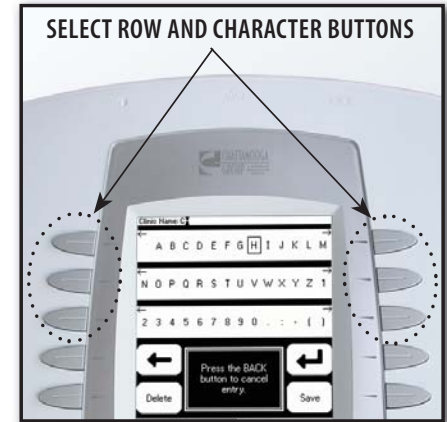

Once selection is framed, press the Accept and Return Arrow button. The character just chosen will display in the top of the screen and the cursor will advance to the next character.

To go back a character press the Move Left Arrow button. To delete the character, press the Delete button.

Once Clinic Name is completed, press the Save button.

To discard entry, press the Back button.

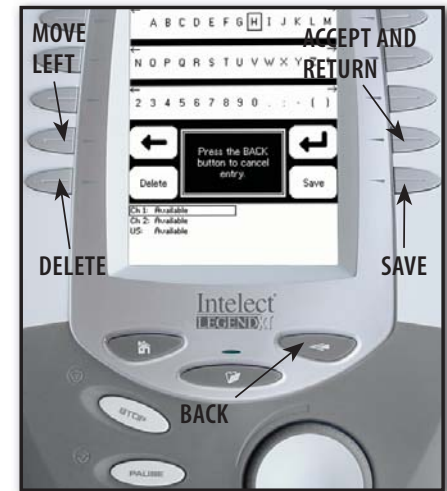





# SETUP

## THERAPY SYSTEM SETUP (CONTINUED)

### Restoring Default Protocols

Press Restore Default Protocols button.

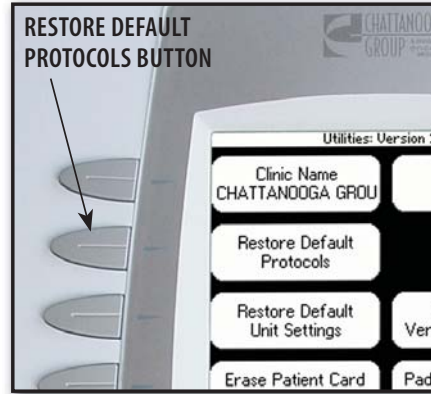

### Restoring Default Unit Settings

Press the Restore Default Unit Settings button to restore the system defaults. This control will neither change the Date and Time nor affect any of the Clinical Protocols stored in the system.

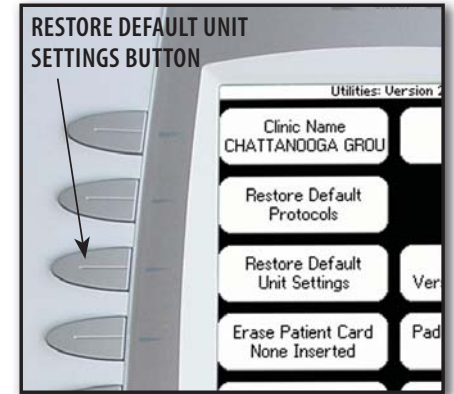

Press Yes button to restore the Protocols to Factory Settings. This will permanently remove all User Protocols and Sequences.

**NOTE:** This will permanently remove all User Protocols.

If it is not desired to permanently remove all of the User Protocols and User Sequences from the System, press the No button.

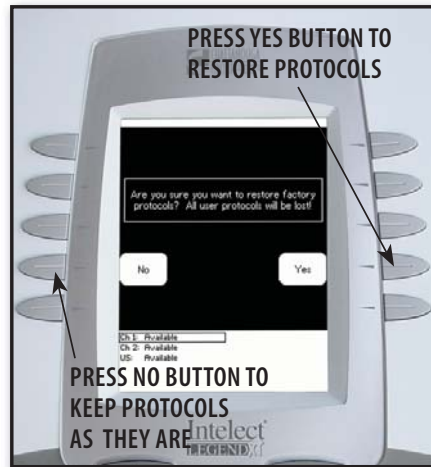

After the settings have been restored, a message will appear stating that the Default Unit Settings are restored. Press any button to return to Utilities screen.

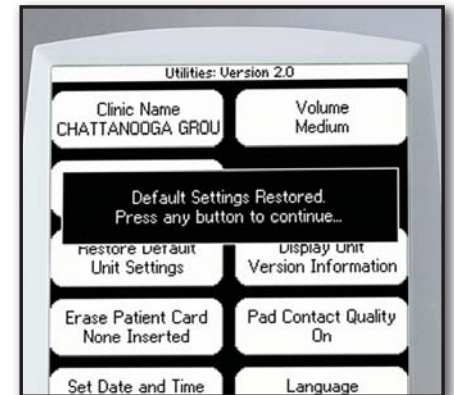



# SETUP

## THERAPY SYSTEM SETUP (CONTINUED)

### Erasing Patient Data Card

Install Patient Data Card to be erased into Patient Data Card Access Port on the system.  
Press Erase Patient Card button.

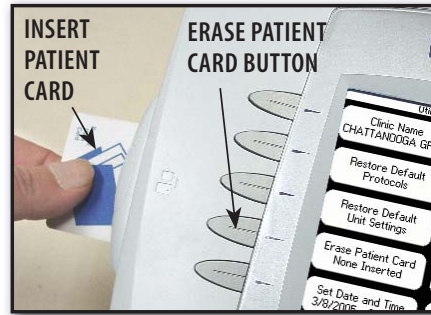

Press the Yes button to erase all data from Patient Data Card.  
Press the No button to keep all data on Patient Data Card.

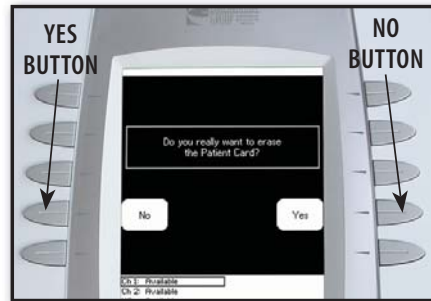

After Patient Data Card is erased, a verification message will appear. Press any button to return to the Utilities screen.



### Setting Date and Time

Press Set Date and Time button.

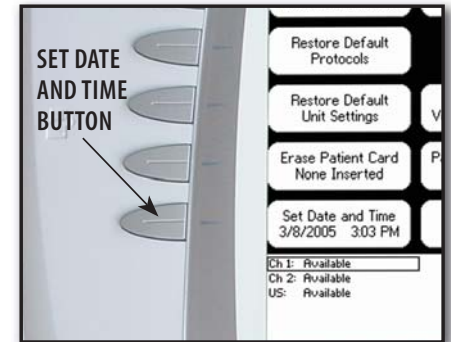

Press the UP or Down Arrow button for the respective area until desired change is displayed.

After all desired changes are made, press the Back button to return to the Utilities screen.

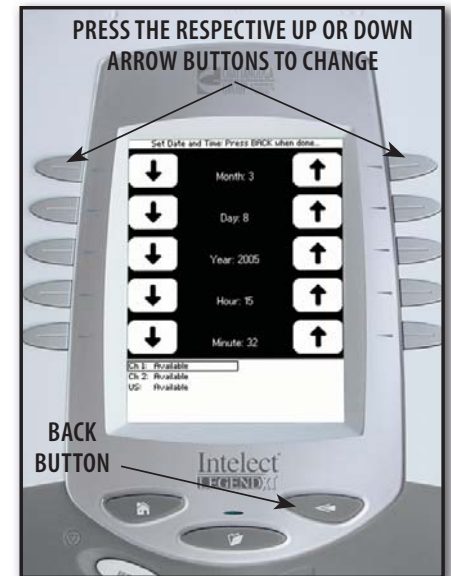



# SETUP

## THERAPY SYSTEM SETUP (CONTINUED)

### Setting System Volume

Press Volume button until the desired system volume is achieved. There are six settings: Off, X-Low, Low, Med, High and X-High.

Each time the Volume button is pressed the setting displayed will emit three beep tones at that level.

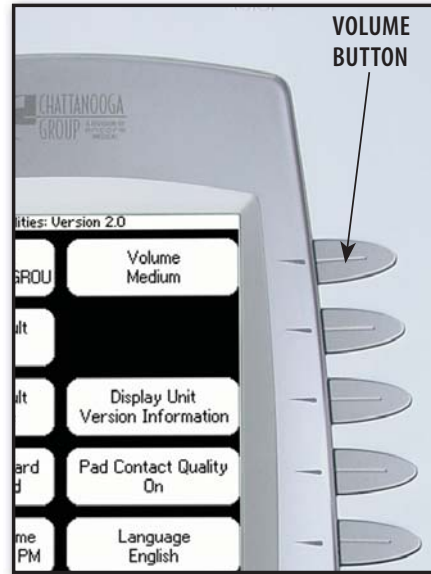

### Displaying Unit Version Information

Press the Display Unit Version Information button to show the system software versions installed.

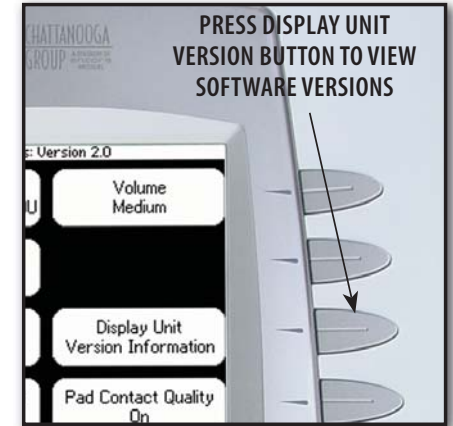

Press the Back button to return the Operator Utilities screen.





# SETUP

## THERAPY SYSTEM SETUP (CONTINUED)

### Pad Contact Quality

The Pad Contact Quality feature indicates to the user the contact quality of the electrodes on the patient. This function, if On, displays a bar graph at the bottom of Treatment Review screen for the following waveforms only:

The Therapy System Pad Contact Quality default is ON.

- **Interferential:**

Dual Channel Graph

- **IFC Premod (2p):**

Single Channel Graph

- **Russian:**

Single Channel Graph

To turn On or Off, press Pad Contact Quality button until On or Off as desired is displayed.

Single Channel Waveforms will display a single bar graph. Dual Channel waveforms will display a double bar graph.

Contact quality is measured by the amount of the graph filled with black.

An ideal contact quality is 75% or more of the graph filled.

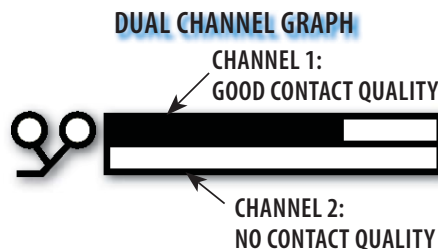
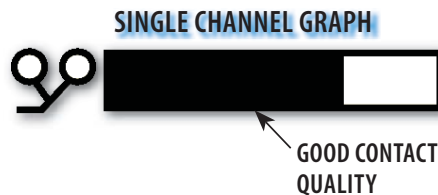
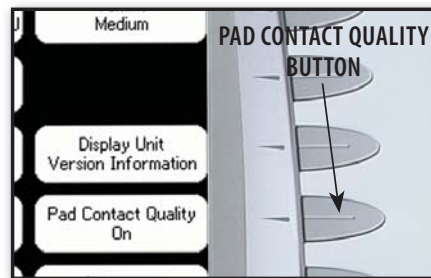

### Selecting Language

To change the language displayed on the system, press the Language button until the desired language is displayed.

Press Home button to set the language and return to Home screen.

If Unit Default Settings are restored, the language will revert back to English.

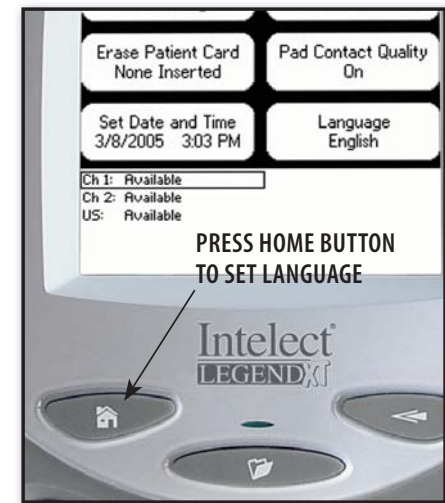
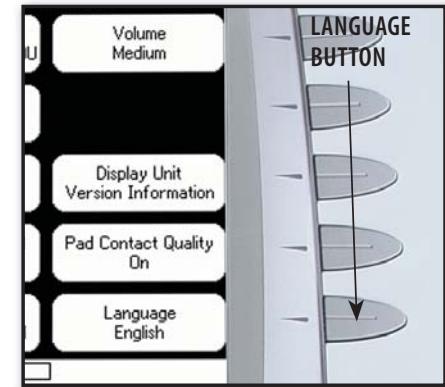

TOC





# SETUP

## THERAPY SYSTEM SETUP (CONTINUED)

### Connecting Accessories to the Therapy System

Install Lead Wires, Ultrasound Applicator, Patient Interrupt Switch, and any other accessories according to the Front Access Panel as illustrated below. **Refer to page 13** for Symbol Definitions.

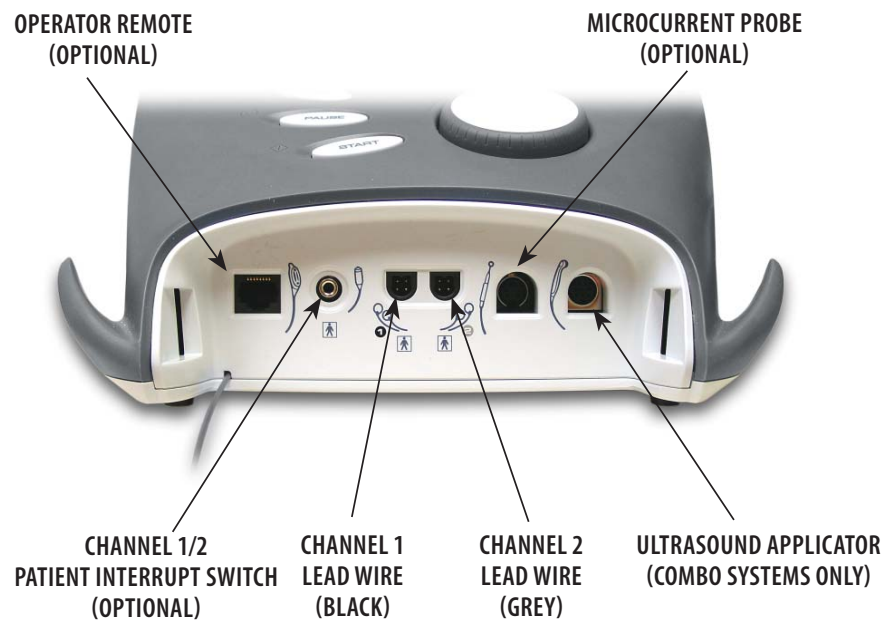



# PATIENT PREPARATION

## ELECTROTHERAPY PATIENT PREPARATION

### Electrode Placement

- Examine the skin for any wounds and clean the skin.
- Apply the electrodes to the treatment area.
- Ensure the electrodes are applied securely to the skin.
- Ensure good contact between each electrode and the skin.
- Check the electrode contact regularly during the treatment.
- Examine the skin again after the treatment.
- Choose electrodes that fit the anatomy.
- Refer to the respective electrode type instructions on **pages 28 through 30**.
- Follow electrode manufacturer instructions.



## WARNING

- Keep electrodes separated during treatment. Electrodes in contact with each other could result in improper stimulation or skin burns.
- Output current density is related to electrode size. Improper application may result in patient injury. If any question arises as to the proper electrode size, consult a licensed practitioner prior to therapy session.
- Powered muscle stimulators should be used only with the leads and electrodes recommended for use by the manufacturer.



# PATIENT PREPARATION

## ELECTROTHERAPY PATIENT PREPARATION (CONTINUED)

### DURA-STICK™ Electrodes

Chattanooga Group DURA-STICK™ Electrodes are a self adhesive, single patient, one time use disposable product designed specifically for use with Chattanooga Group Electrotherapy systems.

It is recommended that Chattanooga Group DURA-STICK™ Electrodes be used whenever possible to ensure the highest level of contact with the treatment area and most uniform delivery of the prescribed electrotherapy treatment.

Properly dispose of used DURA-STICK™ Electrodes upon completion of the therapy session.



### Reusable Carbon Electrodes (Optional)

If used for delivery of electrotherapy, the Carbon Electrodes must be used with a conductive medium such as Conductor™ Transmission Gel.

These Carbon Electrodes should be secured to the treatment area using Nylatex® Wraps.





# PATIENT PREPARATION

## ELECTROTHERAPY PATIENT PREPARATION (CONTINUED)

### Dura-Stick™ Electrode Instructions

#### Connecting Lead Wires

Insert the lead with the Red (+) electrode connector into one DURA-STICK™ Electrode. Insert the lead with the Black (-) electrode connector into the other electrode.

Make certain the lead wires are seated completely into the electrodes.

**NOTE:** Use of conductive medium or sponges is not required or recommended. DURA-STICK™ Electrodes are manufactured to ensure the optimum conductivity during therapy when properly applied.

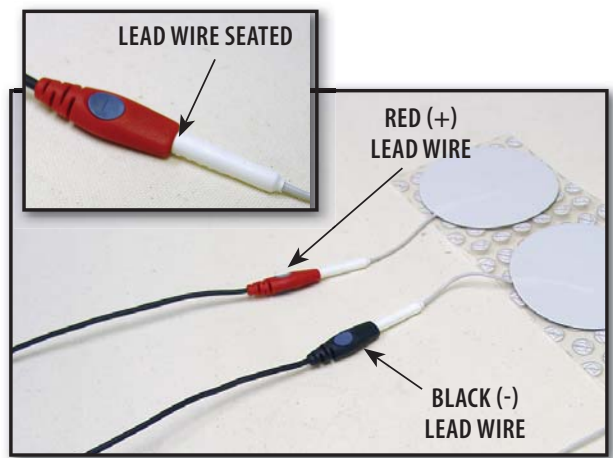

#### Securing Electrodes

Remove the DURA-STICK™ Electrodes from the protective backing and apply to the treatment area as prescribed. Ensure the entire electrode surface is in contact with patient skin by pressing into place.





# PATIENT PREPARATION

## ELECTROTHERAPY PATIENT PREPARATION (CONTINUED)

### Reusable Carbon Electrodes (Optional)

#### Connecting Lead Wires

Insert the lead with the Red (+) electrode connector into Red electrode. Insert the lead with the black (-) electrode connector into the Black electrode.

Make certain the lead wires are seated completely into the electrodes.

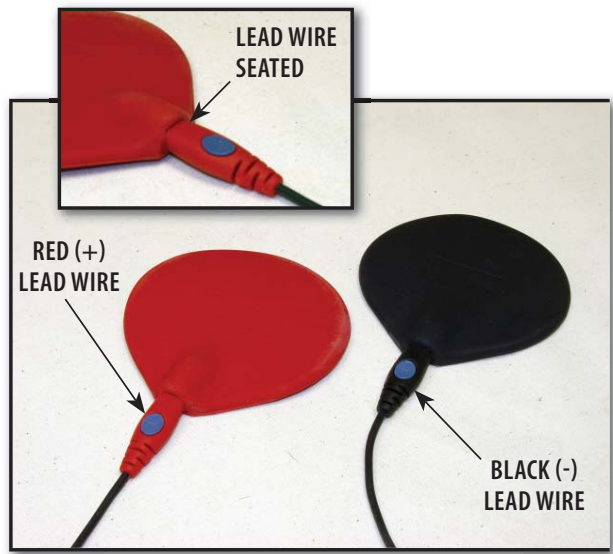

#### Conductive Medium

Liberal apply Conductor™ Transmission Gel to electrode prior to placement on patient.



#### Securing Electrodes

Use Nylatex® Wrap to secure each electrode in position on the patient.

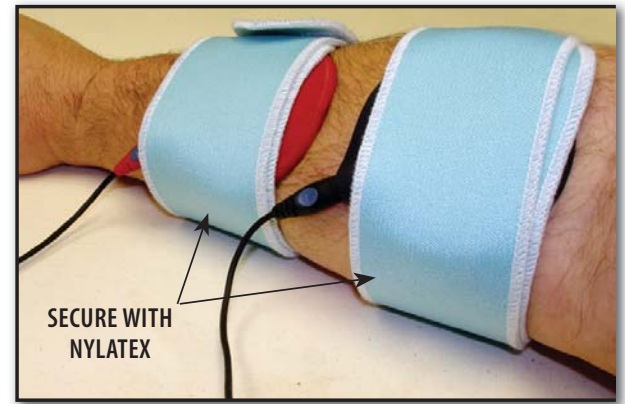

**! CAUTION**

Nylatex® Wraps contain dry natural rubber and may cause allergic reactions in patients with allergies to latex.





# PATIENT PREPARATION

## ULTRASOUND PATIENT PREPARATION

### Preparing Treatment Area

Examine the skin for any wounds and clean the skin.

### Size of Applicator

Sound Heads are available in the sizes shown below.



### Applicator Preparation

Clean applicator before each therapy session with warm soapy water.

### Conductive Medium

Liberal apply Conductor™ Transmission Gel or equivalent to the treatment area on the patient.



### Treatment Area

Move the Sound Head during therapy session in a circular motion. The area treated should be two times the diameter of the Sound Head.

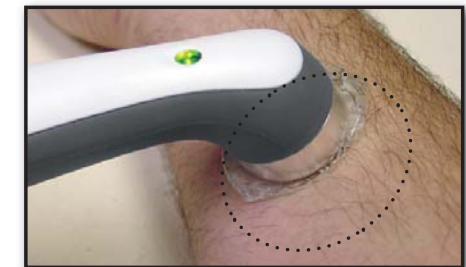

### Applicator LED

After pressing the Start button to begin Ultrasound Therapy, the Applicator LED will illuminate green indicating that the Applicator is emitting Ultrasound.

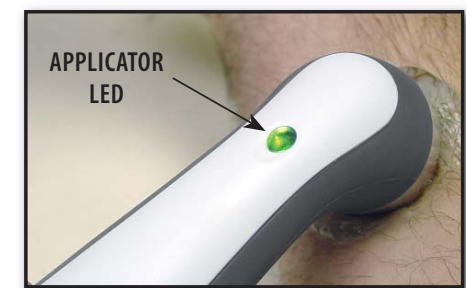





# OPERATION

## OPERATOR INTERFACE

The Intelect Legend XT Therapy System Operator Interface houses all of the functions and controls necessary for the operator to access all operator utilities, modalities, and parameters for modification and system setup.



- 1. Top of Screen**  
The Title Bar indicates the Screen Title for the modality being used. When at the System Home screen, the Clinic Name is displayed.
- 2. Center of Screen**  
Contains available Modality options. Select Modality by pressing the desired Modality button and then make parameter modifications.
- 3. Bottom of Screen**  
Displays available channels and their respective status. Displays Treatment Time and status. After starting therapy session, Modality and Parameter buttons are used to select and modify channel parameters.
- 4. Unit On Indicator**  
Illuminates green when System is connected to an AC mains power source. When the System is On, the indicator will illuminate blue. With System On, and if the system sits unused, the Screen Saver initiates (blank screen) and the Blue Indicator will flash.
- 5. Back button**  
Used to return back one screen. Used in conjunction with the Home button to access the Operator Utilities screen.
- 6. Clinical Resources Library button**  
Used to access User Protocols screen.
- 7. Intensity knob**  
Rotate clockwise to increase Modality intensity. Rotate counterclockwise to decrease Modality intensity.
- 8. Start button**  
Press to start therapy session after all initial parameters have been set.
- 9. Pause button**  
Press to pause a therapy session. Press again to restart session.
- 10. Stop button**  
Press to completely stop the therapy session.
- 11. Home button**  
Used to go back to the System Home screen. Used in conjunction with the Back button to access the Operator Utilities screen.
- 12. Modality and Parameter buttons**  
Used to select modality and edit treatment parameters.





# OPERATION

## HOME SCREEN

The Intelect Legend XT Home screen affords access to all of the system modalities and functions. The area surrounding the screen has 10 modality and parameter modification buttons.



- 1. Electrotherapy**  
Accesses all the available waveforms and parameter editing controls.
- 2. Ultrasound**  
Accesses the Ultrasound setup screen and parameter editing controls.
- 3. Combination**  
Accesses combination therapy setup screens and parameter editing controls.
- 4. View/Edit Channel**  
Accesses the selected channel and allows editing of the channel's parameters during therapy. Also used in the saving of information to the Patient Data Card.
- 5. Patient Card**  
Accesses Patient Data Card data.
- 6. Select Channel**  
Use to select desired channel for viewing and editing of channel parameters.





# OPERATION

## ELECTROTHERAPY SCREEN

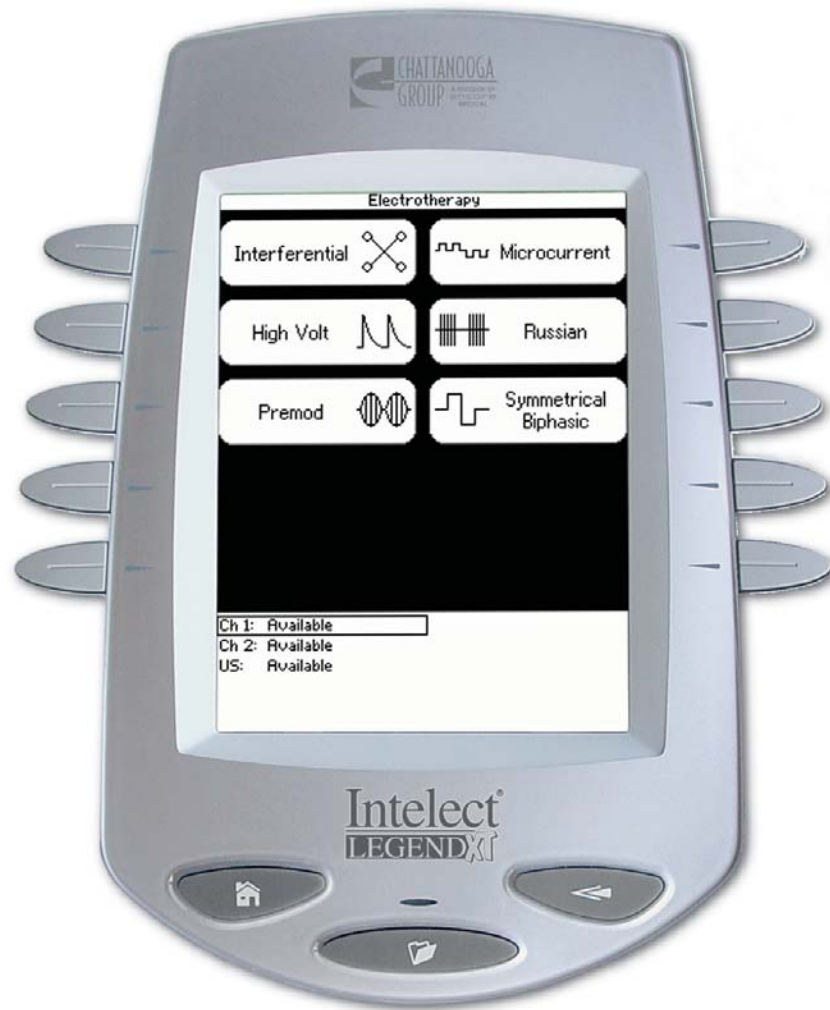

The screen allows the operator to access, set up, and modify parameters of each of the available waveforms within the Intelect Legend XT Therapy System. The following pages give a general explanation of a treatment setup.

Refer to the Specifications section, beginning on **page 15**, for detailed specifications of the system and each available waveform.





# OPERATION

## GENERAL ELECTROTHERAPY WAVEFORM SETUP

The following information is an example of step by step setup for the Electrotherapy waveforms. All waveforms in the Intelect Legend XT Therapy System are set up and edited in the same basic fashion. The following setup instructions use Interferential Waveform.

### Prepare Patient

Refer to **pages 27 through 30** for electrode selection, preparing patient, and securing electrodes.

### Select Modality

Press the Electrotherapy button on the Home screen.

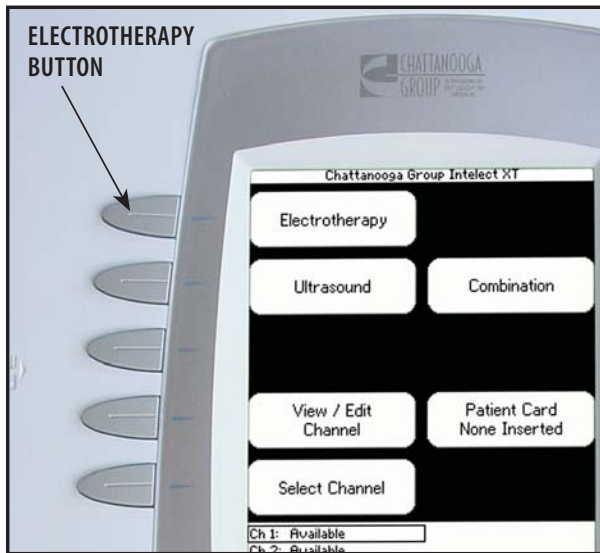

### Select Waveform

Press button beside the desired waveform from the listing on the screen.



**Refer to Specifications section** of this manual for all available waveforms on the Intelect Legend XT Therapy System.

### Edit Waveform Parameters

Press Edit button to access waveform parameters.

Press the corresponding button to edit each parameter as prescribed.

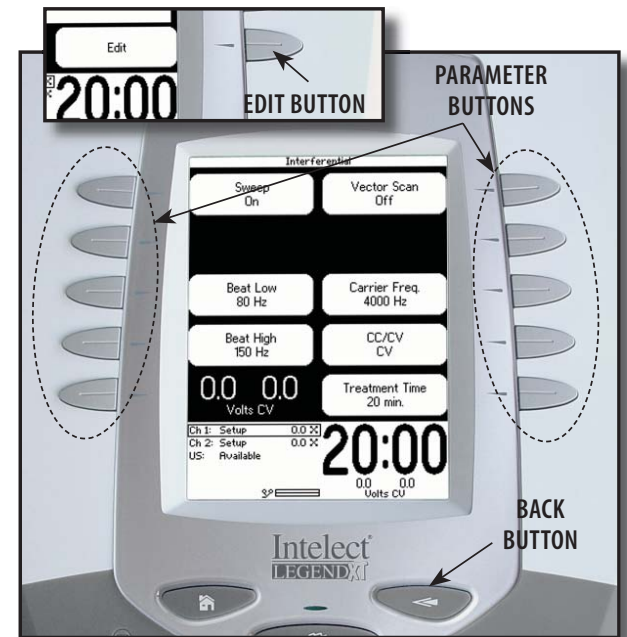

Press the Back button to return to the Treatment Review screen.







# OPERATION

## GENERAL ELECTROTHERAPY WAVEFORM SETUP (CONTINUED)

### Installing Optional Patient Interrupt Switch

Make certain the Patient Interrupt Switch is connected to the Therapy System. Refer to **page 13** for Symbol Definitions.

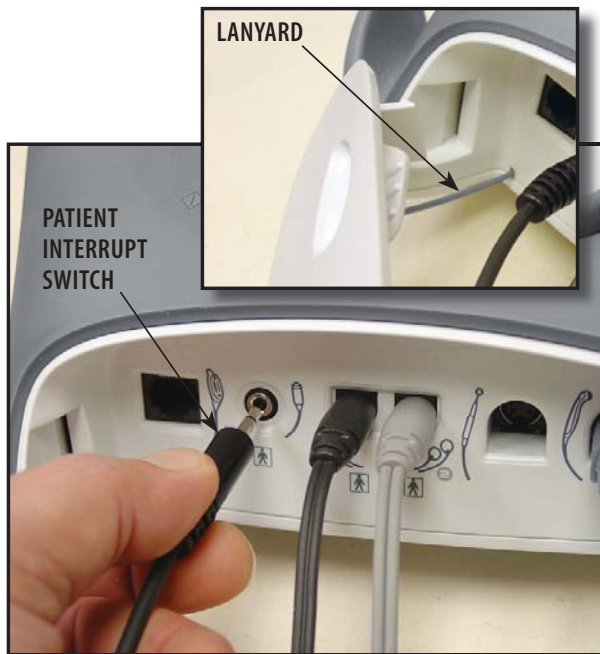

**NOTE:** When reinstalling the Front Access Panel, make certain the Lanyard does not become kinked.

### Optional Patient Interrupt Switch

Give Patient Interrupt Switch to patient and explain that pressing the Red button once pauses the therapy session.

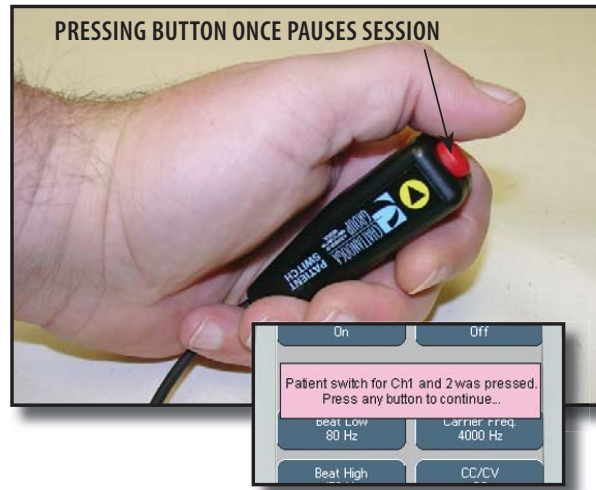

If Patient Interrupt Switch is depressed, the treatment will be paused and a message will appear on the System screen.

Press any button to clear the message.

**NOTE:** If the Patient Interrupt Switch is depressed a second time, the message will clear from the screen and the treatment will remain paused.

### Setting Waveform Intensity

Set intensity by rotating the Intensity Control Knob to the prescribed level.



### Intensity Knob Rotation

**Clockwise-** Increases Intensity

**Counterclockwise-** Decreases Intensity







# OPERATION

## GENERAL ELECTROTHERAPY WAVEFORM SETUP (CONTINUED)

### Start Treatment

Press the Start button to begin therapy session.

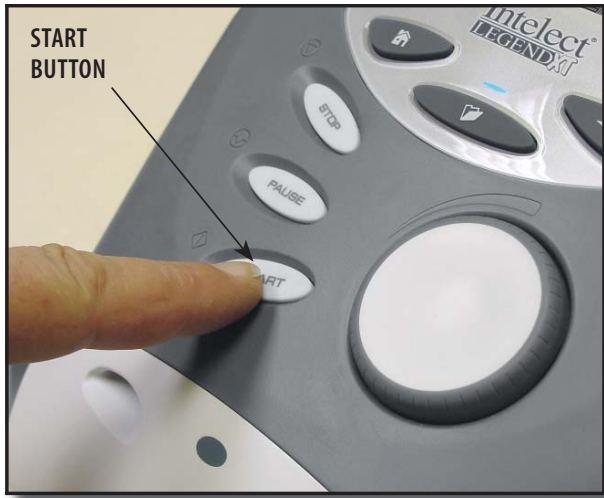

### Pause Treatment

Press the Pause button to pause therapy session and maintain remaining time. To resume treatment, press the Pause button again.



### Stop Treatment

To Stop treatment, press the Stop button once. Treatment will stop and the Completed Treatment Review screen will display.



### Save to Patient Data Card

After session is complete, press the Save to Patient Card button. **Refer to pages 48 through 57** for Patient Data Card Setup and use.





# OPERATION

## ADJUSTING ELECTROTHERAPY CHANNEL PARAMETERS DURING TREATMENT

The Electrotherapy channel parameters may be changed during a treatment session without pausing or stopping the treatment. The waveform Intensity may be increased or decreased at any time during the session without utilizing this process.

### Selecting Channel

Press the Home button.



Press the Select Channel button until the channel desired is framed.

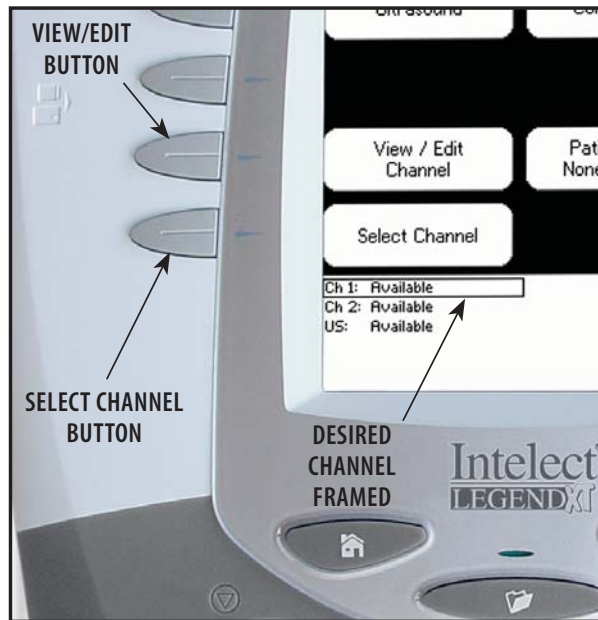

Press the View/Edit Channel button. The Treatment Review screen will display.

### Editing Channel Parameters

Press the Edit button. Edit parameters as desired.

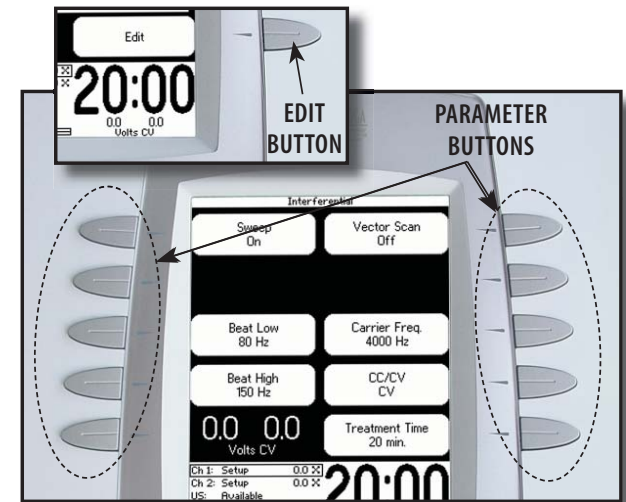

When finished editing the selected channel, press the Home button to select another channel if desired.

To view the Treatment Review screen, if the Home screen is displayed, press the View/Edit Channel button. If the Edit screen is displayed, press the Back button.





# OPERATION

## ULTRASOUND

The following information gives general instructions for the setup of ultrasound therapy when selecting Ultrasound from the Home screen.

### Preparing Patient

**Refer to page 31** for Applicator sizes, patient preparation, and use of conductive medium.

**NOTE:** Use only Intelect Legend XT Ultrasound Applicators. Previous models of Chattanooga Group Ultrasound Applicators will not work with the Intelect Legend XT Therapy System.

### Selecting Modality

Press the Ultrasound button on the Home screen.

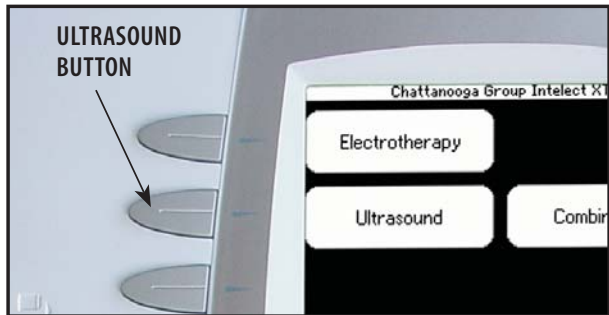

### Editing Ultrasound Parameters

Press Edit button to access ultrasound parameters.

Press the corresponding button to edit as prescribed.

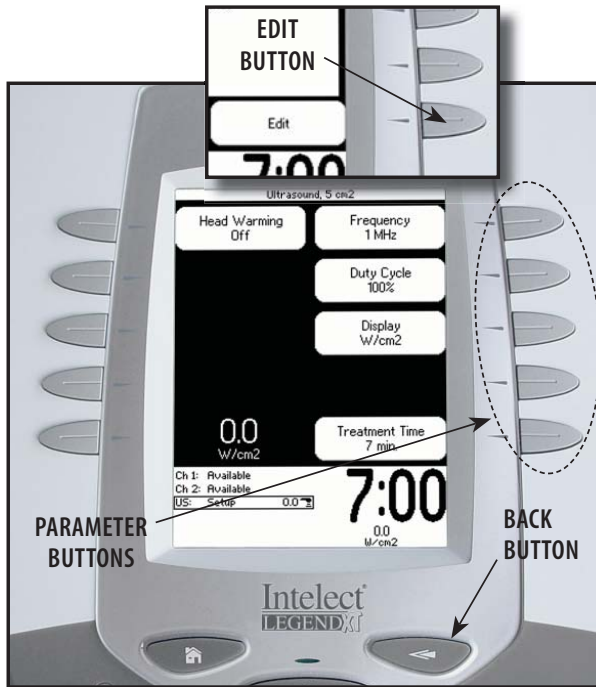

Press the Back button to return to Treatment Review screen.

### Head Warming

The Intelect Legend XT Therapy System incorporates a Head Warming feature that pre-heats the Sound Head of the Applicator for increasing patient comfort. The control for the Head Warming feature is in the Edit screen of the Ultrasound modality.

Press the Head Warming button until On is displayed.

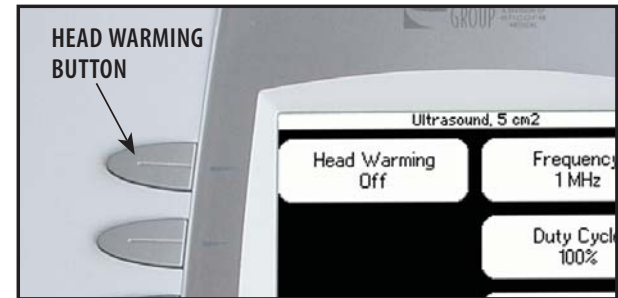

To set the default of the Head Warming feature to On, press the Home button after On is displayed in the Head Warming icon. Head Warming will then start when the Therapy System is turned On.

**NOTE:** Head warming time is approximately 2 minutes.





# OPERATION

## ULTRASOUND (CONTINUED)

### Setting Ultrasound Intensity

Set intensity by rotating the Intensity Control Knob to the prescribed level.



### Intensity Knob Rotation

**Clockwise-** Increases Intensity

**Counterclockwise-** Decreases Intensity

### Starting Treatment

Press the Start button to begin therapy session.

Move the Applicator in a circular motion over the treatment area.

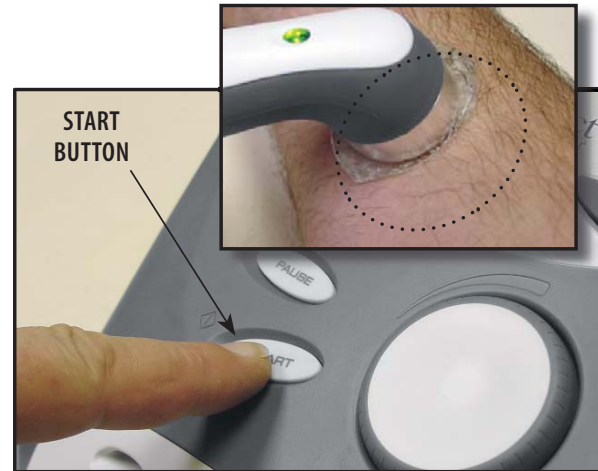

**NOTE:** When the Applicator LED is illuminated, the Applicator is emitting Ultrasound.

### Pausing Treatment

Press the Pause button to pause therapy session and maintain remaining time. To resume treatment, press the Pause button again.

**NOTE:** The Applicator LED will not illuminate when the session has been paused.

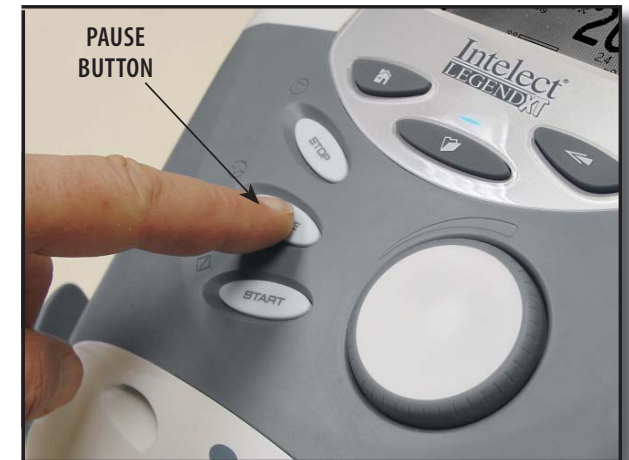





# OPERATION

## ULTRASOUND (CONTINUED)

### Stopping Treatment

To Stop treatment, press the Stop button once. Treatment will stop and the Completed Treatment Review screen will display.

### Saving to Patient Data Card

After session is complete, press the Save to Patient Card button. **Refer to pages 48 through 57** for Patient Data Card Setup and use.







# OPERATION

## ADJUSTING ULTRASOUND PARAMETERS DURING TREATMENT

The ultrasound parameters may be changed during a treatment session without pausing or stopping the treatment. The following information provides instructions for changing ultrasound treatment parameters during a treatment session. The ultrasound intensity may be increased or decreased at any time during the session without utilizing this process.

### Editing Ultrasound from Home Screen

Press Select Channel button until US: Running is framed.

Press View/Edit Channel button.

Press the Edit button on the Treatment Review screen.

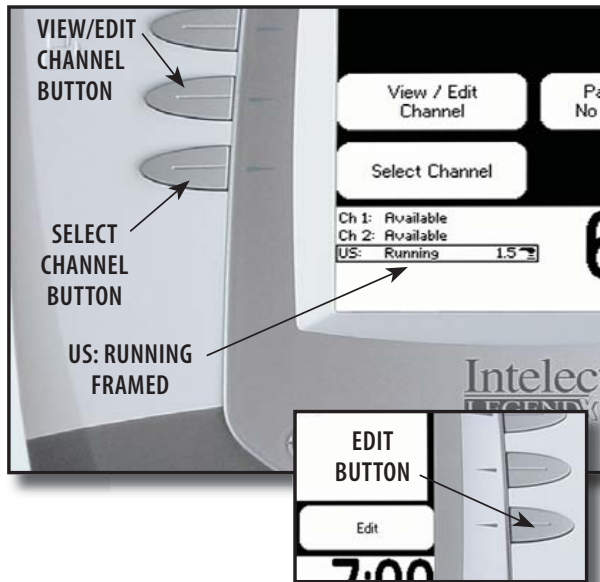

Press the corresponding parameter button and edit as prescribed.

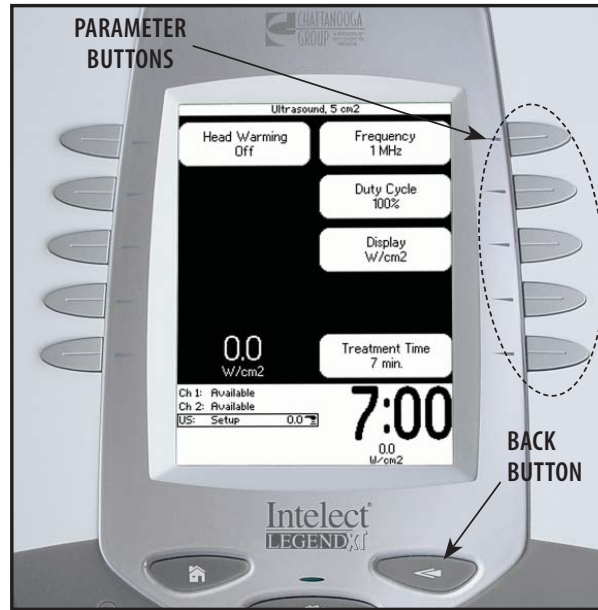

When editing is complete, press the Back button to return to Treatment Review screen.

### Editing Ultrasound from Treatment Review Screen

Press the Edit button on the Treatment Review screen.

Press the corresponding parameter button and edit as prescribed.

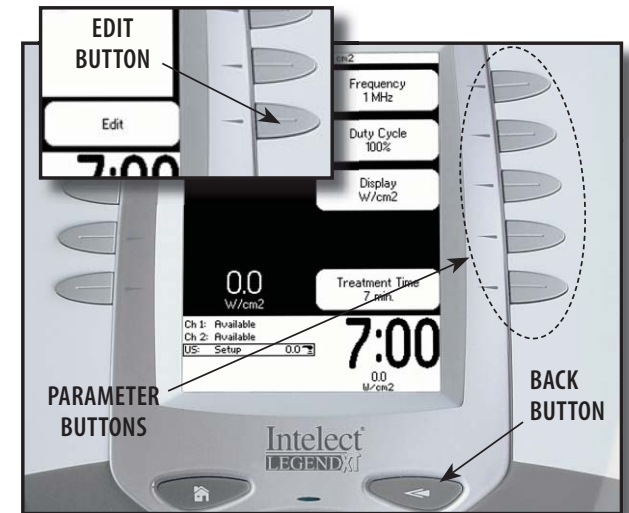

When editing is complete, press the Back button to return to Treatment Review screen.





# OPERATION

## COMBINATION

The Intelect Legend XT Therapy System Combination modality allows the user to select and use ultrasound therapy in combination with electrical muscle stimulation.

Combination therapy utilizes the Ultrasound modality in conjunction with High Voltage Pulsed Current (HVPC), IFC (4p), IFC Premodulated (2p), or Symmetrical Biphasic to generate a therapeutic effect. In this mode of therapy, the Sound Head of the Ultrasound Applicator becomes one half of the electrical circuit. An electrode attached to the Black (+) Lead Wire completes the circuit.

### Preparing Patient

Refer to pages 27 through 30 to prepare patient, select electrode and securing electrodes. Refer to page 31 for Ultrasound patient preparation.

Connect the Black (-) Lead Wire from Channel 2 to the electrode. Make certain the Lead Wire is completely seated in the electrode.

The Red (+) Lead Wire is not used. The Ultrasound Applicator completes the circuit for Combination Therapy.



### Selecting Modality

Press the Combination button on the Home screen.

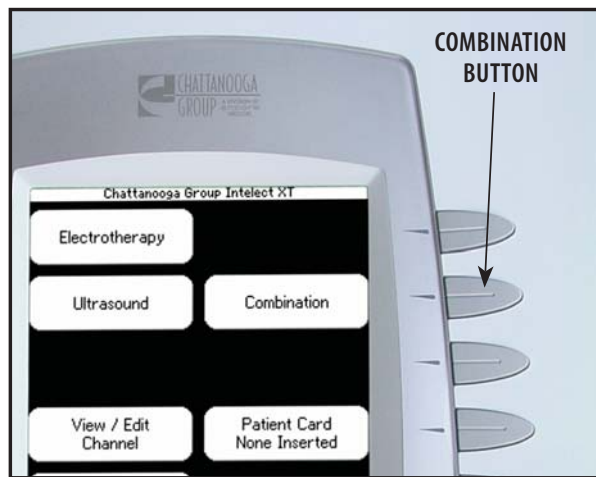

### Accessing Combination Parameters

Press Edit button to access Combination parameters.

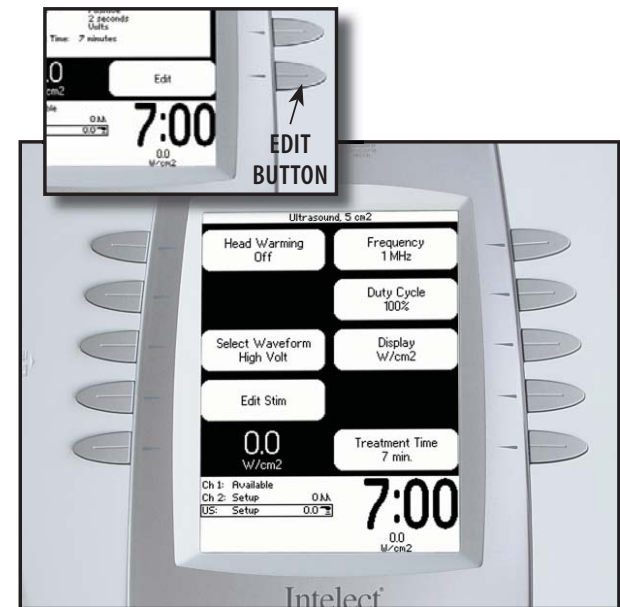

Press the Back button to return to the Treatment Review screen.





# OPERATION

## COMBINATION (CONTINUED)

### Editing Ultrasound Parameters

Press the corresponding button to edit the desired Ultrasound parameter as prescribed.

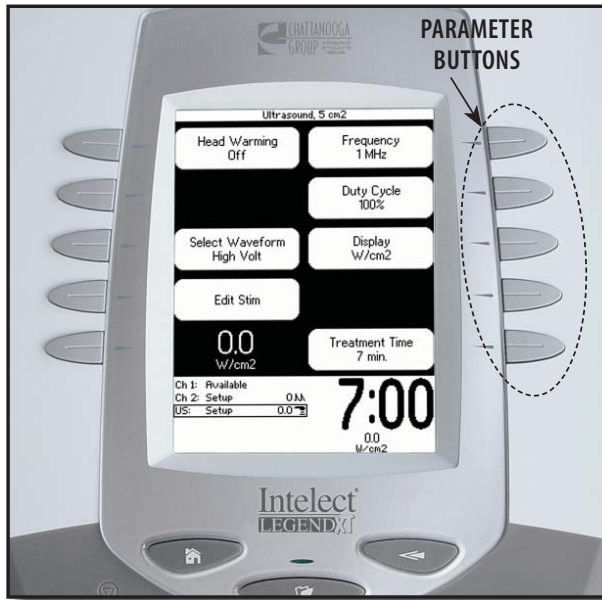

**NOTE:** See page 39 for Head Warming feature instructions.

### Selecting Waveform

Press the Select Waveform button.

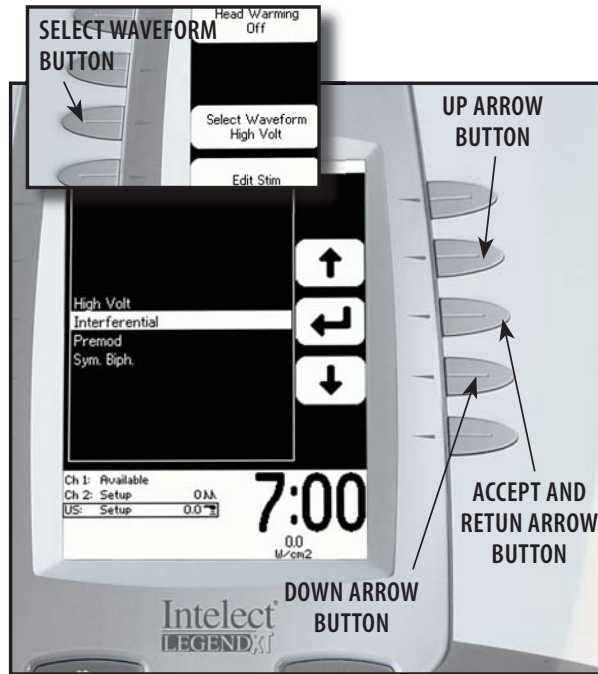

Press the Up or Down Arrow buttons until the prescribed waveform is highlighted. Press the Accept and Return Arrow button.

### Using Optional Patient Interrupt Switch

Connect Patient Interrupt Switch to the Therapy System. Give Patient Interrupt Switch to patient and explain that pressing the Red button once pauses the therapy session.

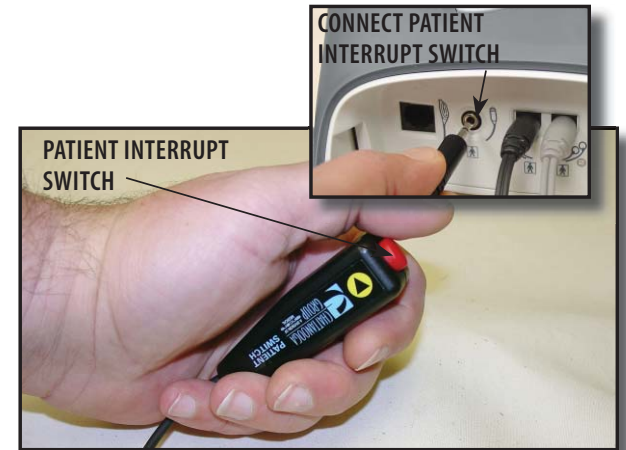

If Patient Interrupt Switch is depressed, the treatment will be paused and a message will appear on the System screen.

Press any button to clear the message.

**NOTE:** If the Patient Interrupt Switch is depressed a second time, the message will clear from the screen and the treatment will remain paused.





# OPERATION

## COMBINATION (CONTINUED)

### Editing Waveform Parameters

Press the Edit Stim button to edit the parameters of the waveform selected.

Press the corresponding button to edit each parameter as prescribed.

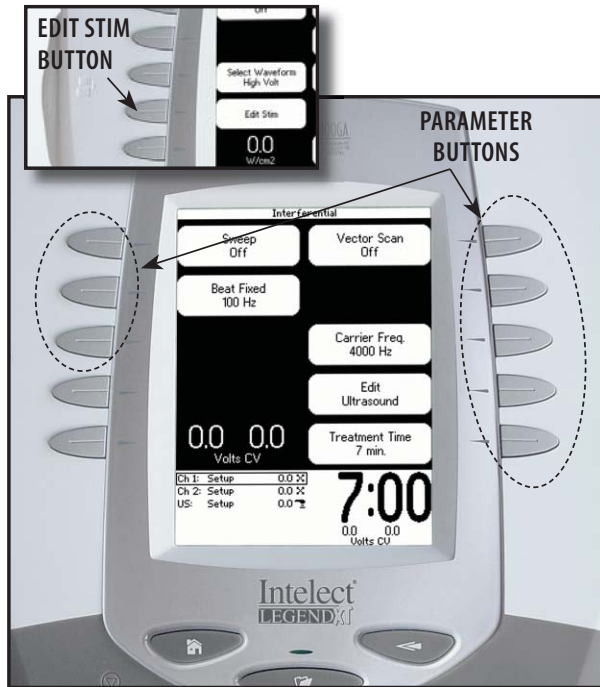

### Setting Waveform Intensity

Set intensity by rotating the Intensity Control knob to the prescribed level.



### Intensity Knob Rotation

**Clockwise-** Increases intensity

**Counterclockwise-** Decreases intensity

### Setting Ultrasound Intensity

Press the Edit Ultrasound button.

Set Ultrasound intensity by rotating the Intensity Control knob to the prescribed level.

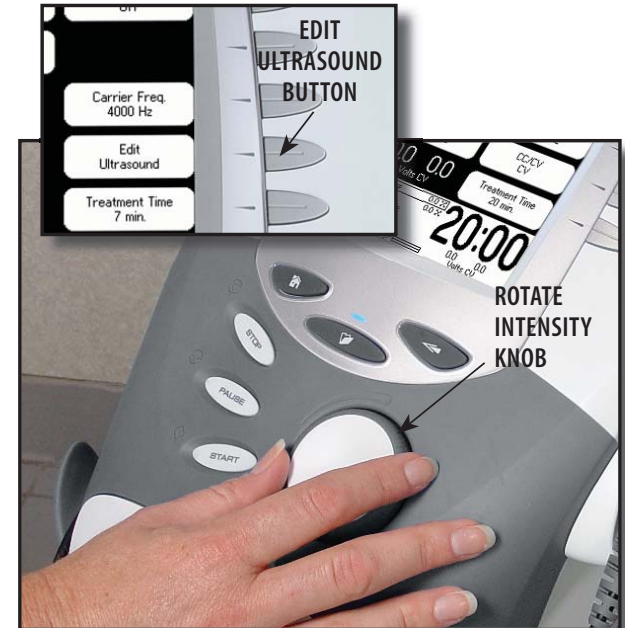

### Intensity Knob Rotation

**Clockwise-** Increases intensity

**Counterclockwise-** Decreases intensity







# OPERATION

## COMBINATION (CONTINUED)

### Starting Treatment

Press the Start button to begin therapy session.

Move the Applicator in a circular motion on the treatment area.

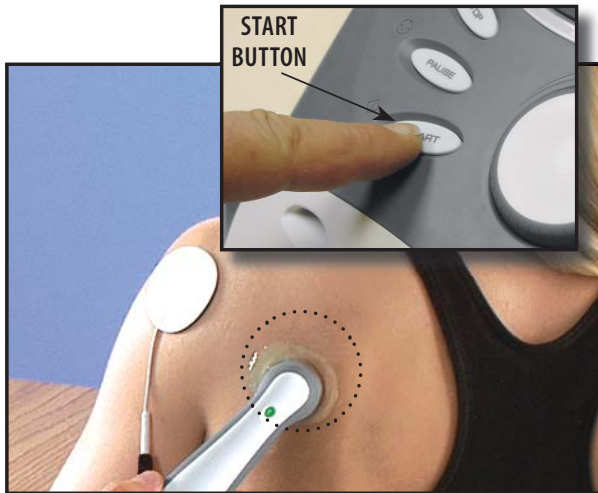

### Pausing Treatment

Press the Pause button to pause therapy session and maintain remaining time. To resume treatment, press the Pause button again.

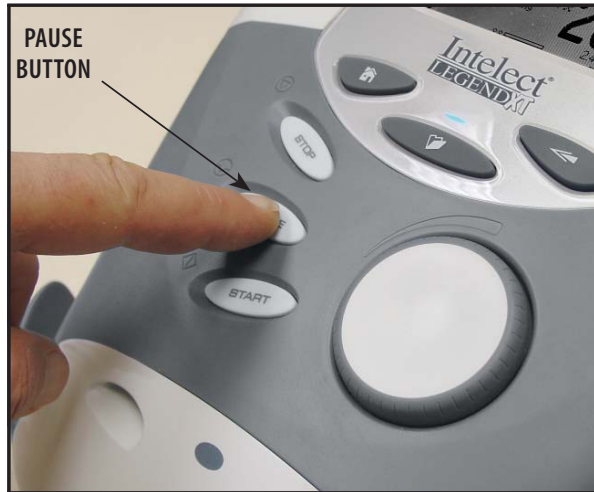

### Stopping Treatment

To Stop treatment, press the Stop button once. Treatment will stop and the Completed Treatment Review screen will display.



### Saving to Patient Data Card

After session is complete, press the Save to Patient Card button. **Refer to pages 48 through 57** for Patient Data Card Setup and use.







# OPERATION

## ADJUSTING COMBINATION PARAMETERS DURING TREATMENT

The channel parameters may be changed during a treatment session without pausing or stopping the treatment. The following information provides instructions for changing Combination Treatment Electrotherapy Channel and Ultrasound parameters during a treatment session.

### Editing Waveform Parameters

Press the Edit Stim button to edit the parameters of the waveform selected. Press the corresponding button to edit each parameter as prescribed.

Rotate the Intensity knob to increase or decrease waveform intensity as prescribed.

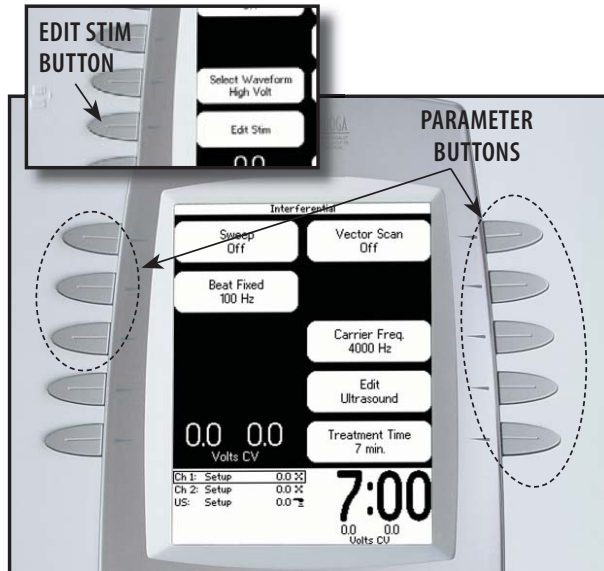

### Editing Ultrasound Parameters

Press the Edit Ultrasound button. Press the corresponding button to edit the desired Ultrasound parameter as prescribed.

**NOTE:** To edit parameters from the Home screen, [see page 38](#) for selecting channel instructions.

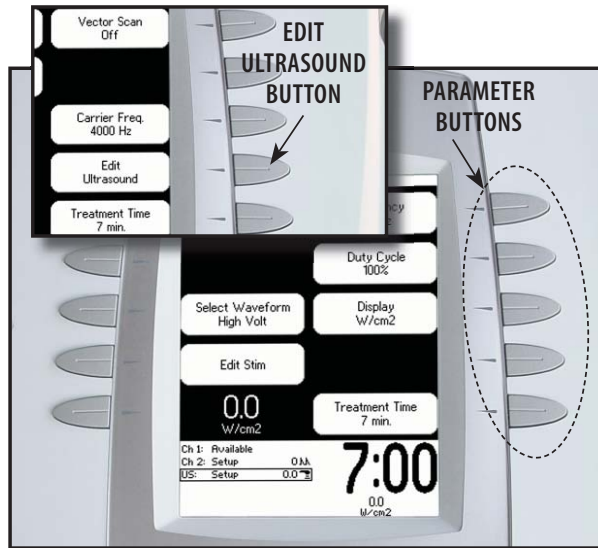

**NOTE:** [See page 39](#) for Head Warming feature instructions.





# OPERATION

## PATIENT DATA CARD- SETTING UP OF NEW CARD

### General Information

The Intelect Legend XT Therapy System incorporates a Patient Data Card reading and recording device that allows transfer of patient therapy data from the system to the card for reviewing patient modality and pain profile information. Information may be transferred to a PC via the optional Patient Data Management System. The PC software is designed to allow easy access to patient data and printing of reports as well as adding session notes to the Patient Data Card.

The reading and recording device allows storage and recall of the following patient session data onto the Patient Data Card: therapy session parameters, Electrode Placement, Pain Map, Numeric Pain Scale or Visual Pain Scale, and Session Notes (stored on card via PC only). Each Patient Data Card can store multiple sessions and each session can be recalled on the Intelect Legend XT Therapy System.

### Inserting New Patient Data Card

Insert a new Patient Data Card into the system access port as shown below. The Therapy System will automatically format the new Patient Data Card and a verification message will appear.

Press any button to continue.



### Setting up Treatment

Setup the patient's prescribed treatment. Refer to the appropriate area of this manual for modality setup.

Administer treatment as prescribed. When treatment is complete, the Treatment Review screen will be visible.

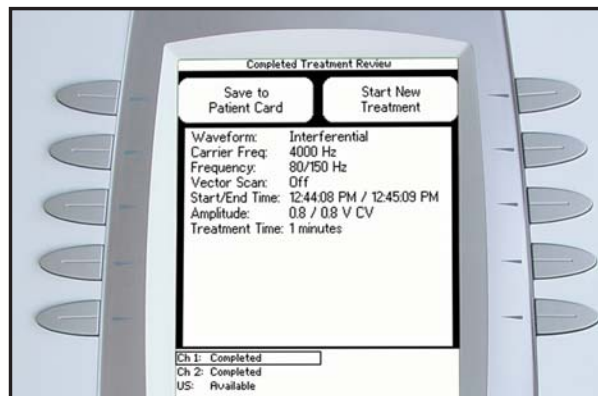

### Setting up a New Patient Data Card

With new Patient Data Card inserted in the system, press the Save to Patient Card button.

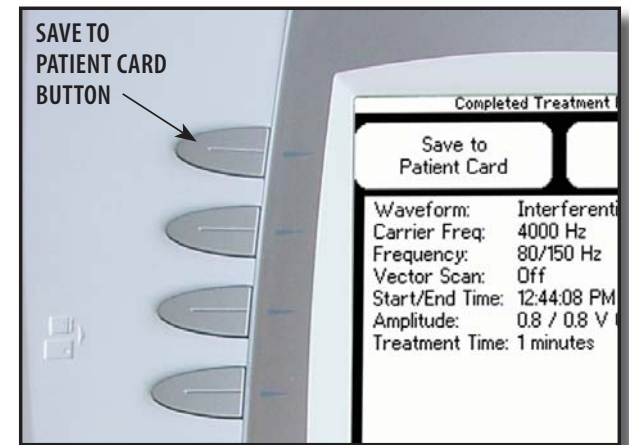



# OPERATION

## PATIENT DATA CARD- SETTING UP OF NEW CARD (CONTINUED)

### Entering Patient ID

Select the row of alpha or numeric characters desired by pushing the button beside the corresponding row. Select the desired character in the row by pressing the row button until the desired letter is framed.

When the desired character is framed, press the Accept and Return Arrow button. The character selected will display in the top of the screen and the cursor will advance to the next position.

To move back a character, press the Left Arrow button.

To delete a character, press the Left Arrow button until the character to be deleted is framed. Press the Delete button.

To discard entire entry, press the Back button.

Repeat this procedure until the desired Patient ID is entered.

After Patient ID is entered, press the Save button.

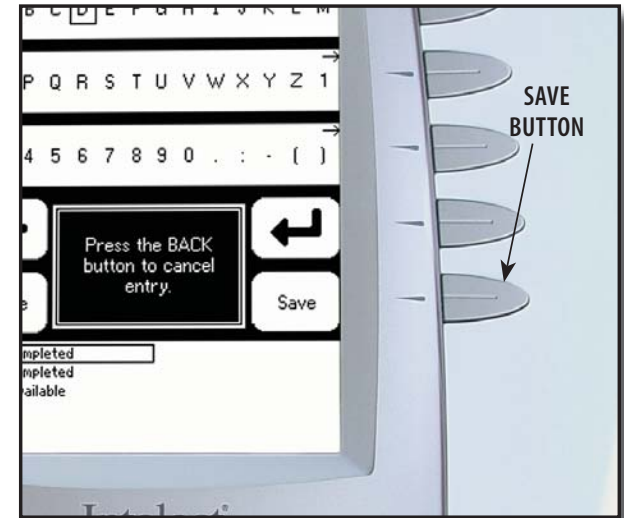
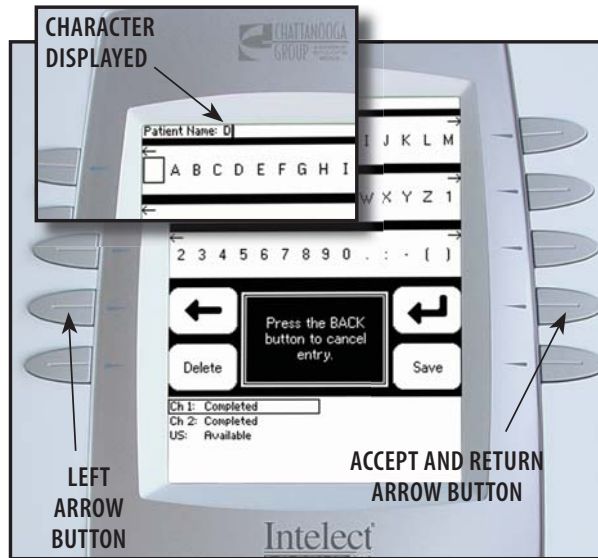
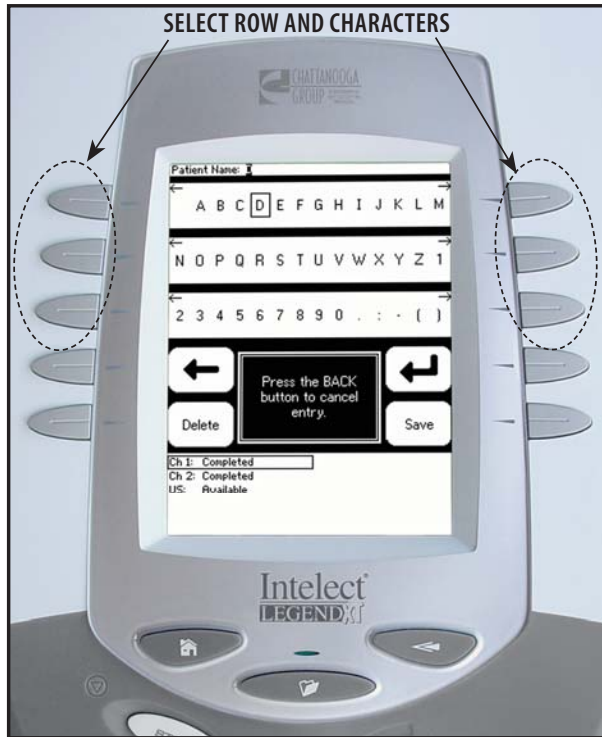

**NOTE:** To add a space, select the area to the left of the letter A.





# OPERATION

## PATIENT DATA CARD- SETTING UP OF NEW CARD (CONTINUED)

### Accessing Electrode Placement

The following information uses an IFC Treatment as an example. Electrode Placement procedures for all modalities are performed in the same basic fashion.

Press the Electrode Placement button.

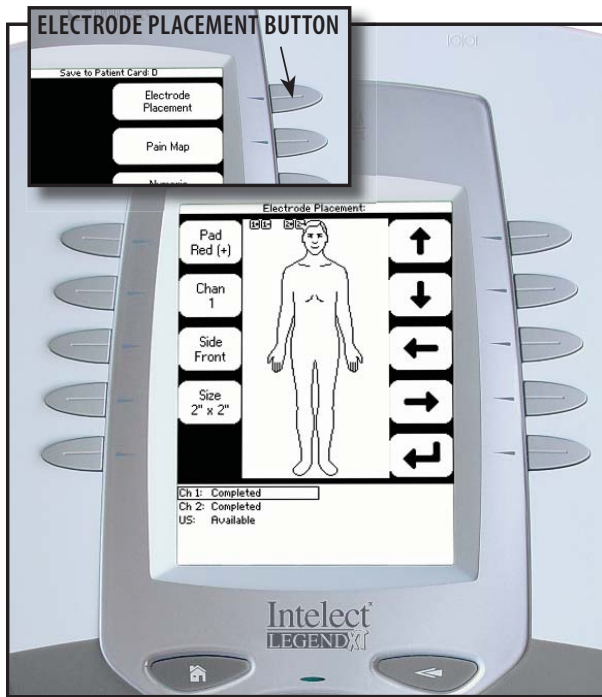

### Setting up Electrodes

Press the Pad button to select the Red (+) or Black (-) electrode.

Press the Chan button to select Channel 1 or Channel 2.

Press the Side button to select Front, Back, Left, or Right of the body graphic.

Press the Size button until desired electrode size is displayed. If electrode desired is not listed, select Other.

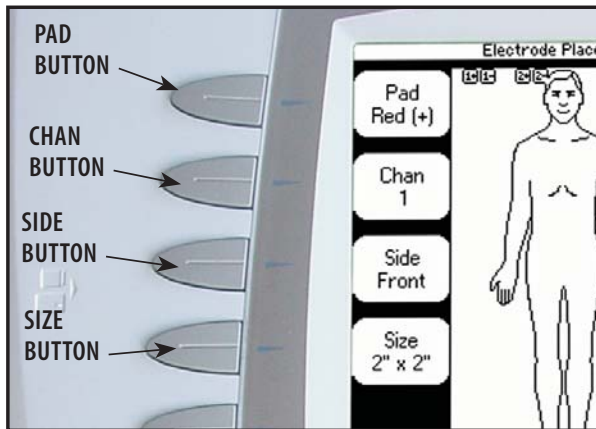

**NOTE:** When Ultrasound is the modality, only the Side button is available.

### Electrode Placement

Press the Up, Down, Left and Right Arrow buttons to position the selected electrode as close to the actual treatment location as possible.

Press the Pad button to select the other electrode. Repeat above procedure for electrode positioning.

If applicable, press the Chan button, to select another channel and repeat above procedures.

After positioning the electrodes, press the Accept and Return Arrow button.

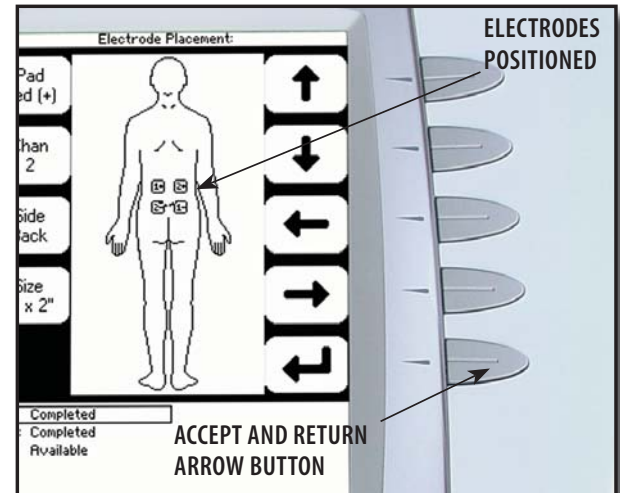





# OPERATION

## PATIENT DATA CARD- SETTING UP OF NEW CARD (CONTINUED)

### Accessing Pain Map

Press the Pain Map button to select the body area of the associated pain as described by the patient.

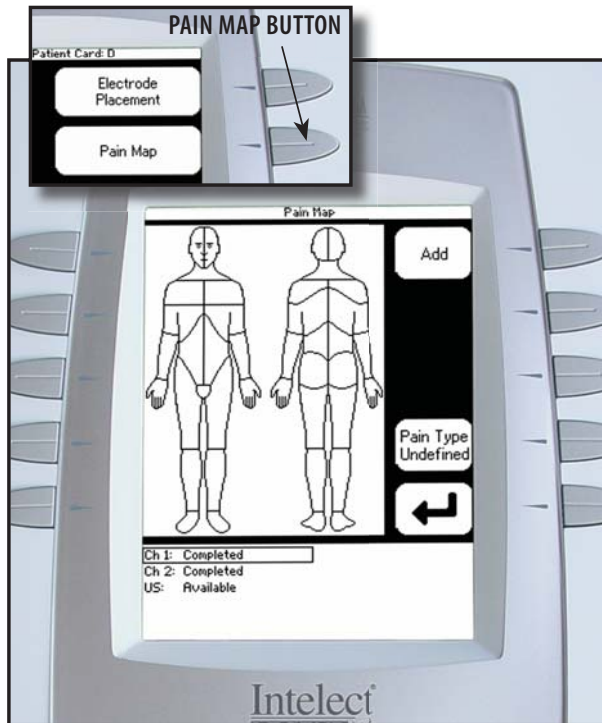

### Selecting Pain Type

Press the Pain Type button until the desired description is displayed in the Pain Type icon.

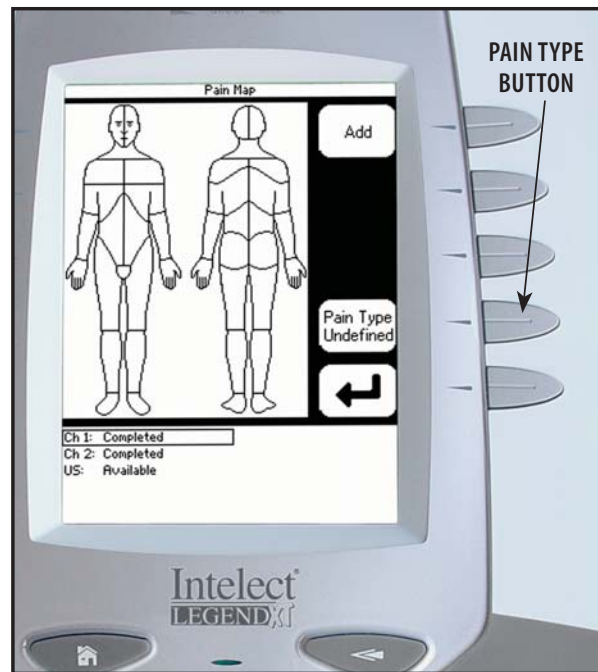

### Adding Pain Locations

Press the Add button. The Add Pain Map window will display.

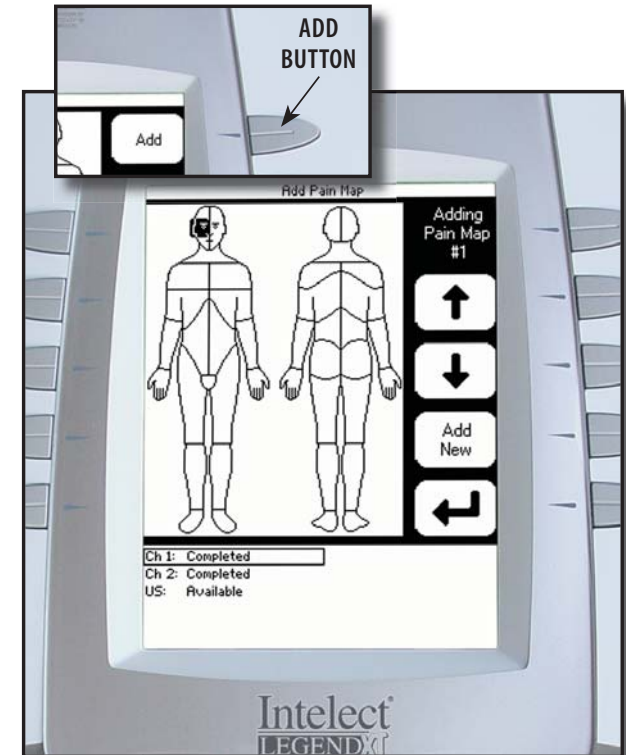

**NOTE:** A maximum of eight Pain Locations may be selected.







# OPERATION

## PATIENT DATA CARD- SETTING UP OF NEW CARD (CONTINUED)

### Selecting Location of Pain

Press the Up and Down Arrow buttons to move the Pain Locator to the area of the body where the pain is located.

Press the Accept and Return Arrow button. The Pain Map window will display.

Press the Add button to continue selecting, in sequence, the radiating path of the pain using the above procedure.

Up to eight pain locations may be selected.

### Editing Pain Locations

Press the Edit button on the Pain Map window.

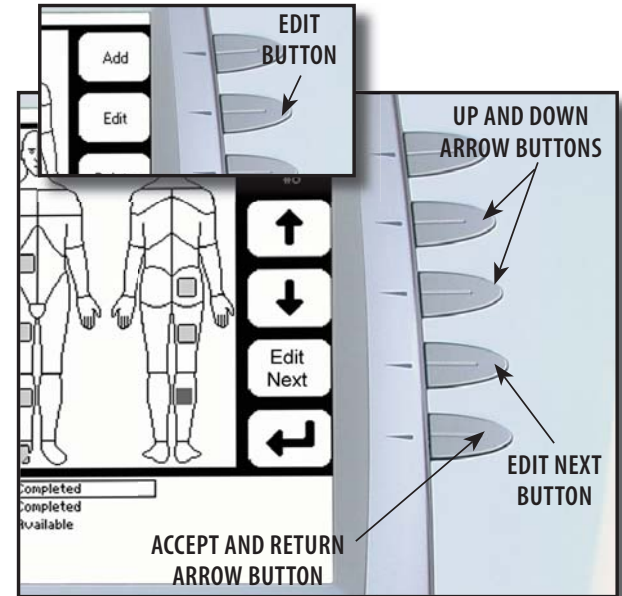
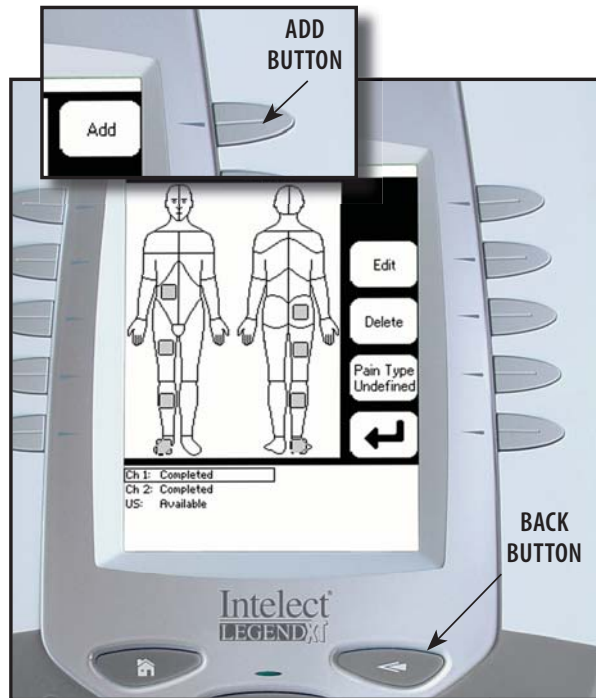
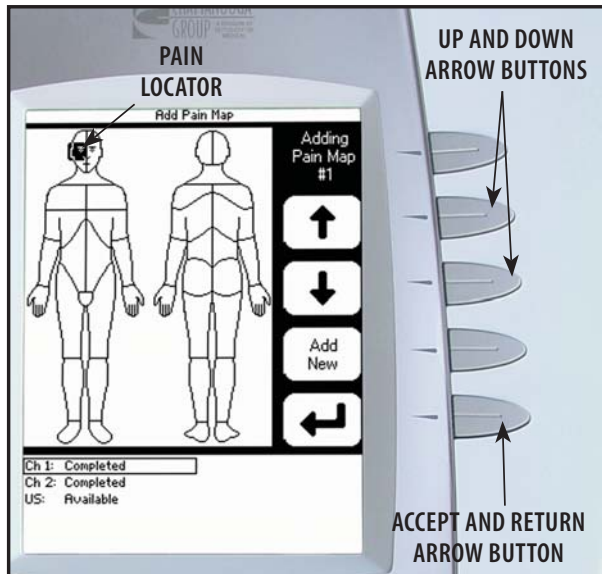

After all desired Pain Locations have been made, press the Back button.

Press the Edit Next button to highlight the Pain Location to be edited.

Use the Up and Down Arrow buttons to relocate the selected Pain Location.

Press the Accept and Return Arrow button. Repeat until all editing is complete, then press the Back button.





# OPERATION

## PATIENT DATA CARD- SETTING UP OF NEW CARD (CONTINUED)

### Deleting Pain Locations

Press the Delete button on the Pain Map window.

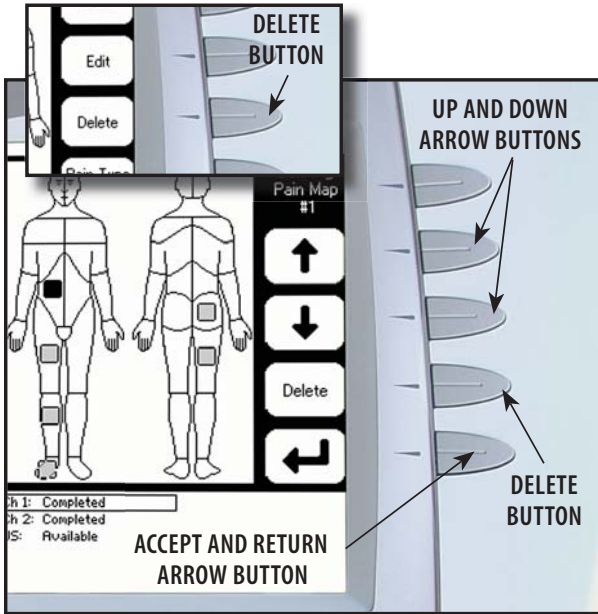

Use the Up and Down Arrow buttons to highlight the Pain Location to be deleted.  
 Press the Delete button.  
 Press the Accept and Return Arrow button.  
 Repeat until all editing is complete, then press the Back button.

### Pain Scales

The Intellect Legend XT Therapy System incorporates two internationally recognized Pain Scales; VAS (Visual Analog Scale), which has no indicator marks and Numeric Scale (indicated 1 through 10). Use either of these for describing the amount of pain the patient is experiencing. When either pain scale is set, the other will automatically set to the corresponding level.

### Selecting Pain Scale

Select the desired Pain Scale by pressing the corresponding button.

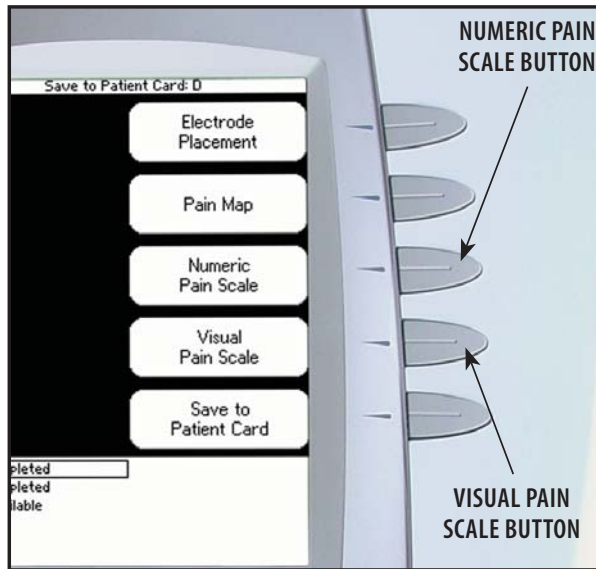

### Adjusting Pain Scale

Press the Left and Right Arrow buttons to adjust the Pain Scale to the level the patient is experiencing.

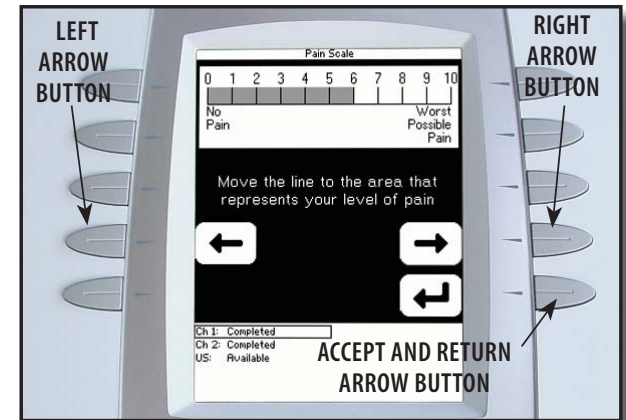

After the desired level is achieved, press the Accept and Return Arrow button.

**NOTE:** Numeric Pain Scale illustrated.



# OPERATION

## PATIENT DATA CARD- SETTING UP OF NEW CARD (CONTINUED)

### Saving to Patient Data Card

After all desired session data has been entered in the Patient Data Card screens, press the Save to Patient Card button. A message will appear stating the data has been saved to the Patient Data Card.

Press any button.

Press the Home button.

Remove the Patient Data Card for filing with patient records.

The Patient Data Card can also be used with the optional Patient Data Management System.

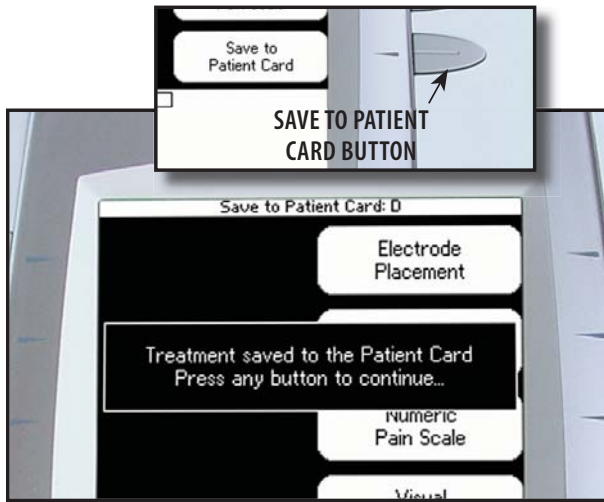

After pressing any button, the Completed Treatment Review screen will display.



# OPERATION

## EXISTING PATIENT DATA CARD USE

### Inserting Existing Patient Data Card

Insert the Patient Data Card assigned to the patient receiving treatment into the system access port as shown below.

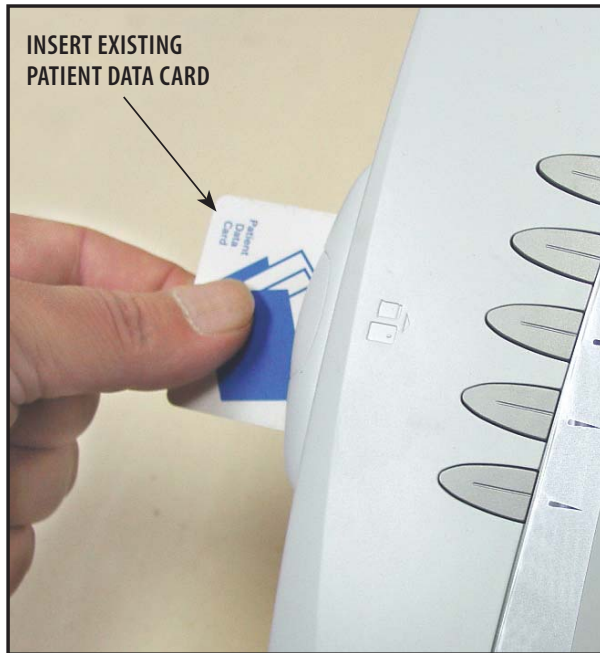

### Accessing Patient Data Card

Press the Patient Card button to access Patient Data Card.

Select the date of the treatment session desired using the Up and Down Arrow buttons until date desired is highlighted.

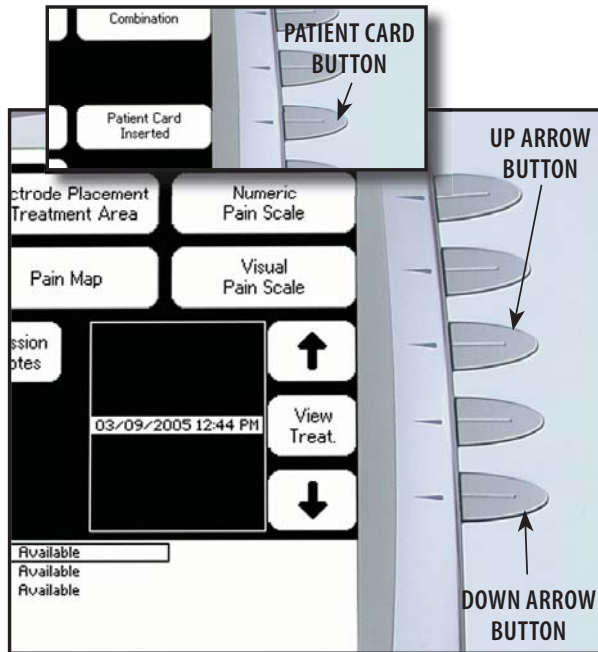

### Viewing Patient Data Card

Press the corresponding button beside the Patient Data to be viewed.

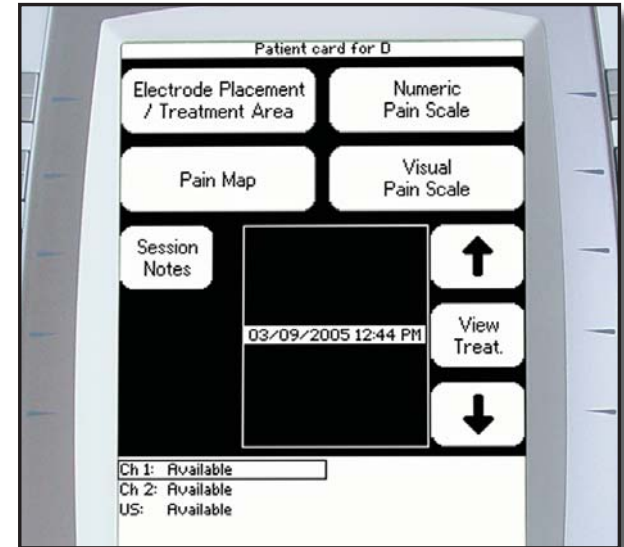

**NOTE:** No Session Notes will be available unless the optional Patient Data Management System was utilized to enter Session Notes onto the Patient Data Card.







# OPERATION

## EXISTING PATIENT DATA CARD USE (CONTINUED)

### Starting a New Treatment from Patient Data Card

Refer to pages 27-30 for Electrotherapy patient preparation, select electrodes, and secure electrodes. Refer to page 31 for Ultrasound patient preparation.

Press the Up and Down Arrow buttons to highlight the desired treatment date and time.

Press the View Treat button.

Press Start New Treatment button.

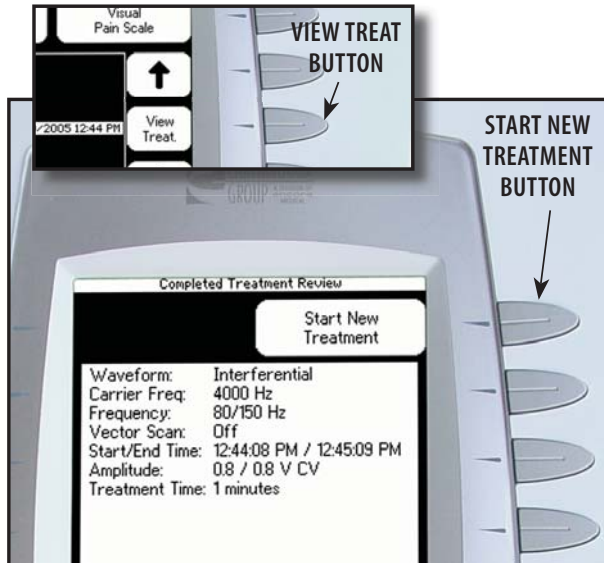

### Using Optional Patient Interrupt Switch

Connect Patient Interrupt Switch to the Therapy System. Give Patient Interrupt Switch to patient and explain that pressing the Red button once pauses the therapy session.



If Patient Interrupt Switch is depressed, the treatment will be paused and a message will appear on the System screen.

Press any button to clear the message.

**NOTE:** If the Patient Interrupt Switch is depressed a second time, the message will clear from the screen and the treatment will remain paused.

### Setting Intensity

Set intensity by rotating the Intensity Control Knob to the prescribed level.



### Intensity Knob Rotation

**Clockwise-** Increases Intensity

**Counterclockwise-** Decreases Intensity







# OPERATION

## EXISTING PATIENT DATA CARD USE (CONTINUED)

### Starting Treatment

Press the Start button to begin therapy session.

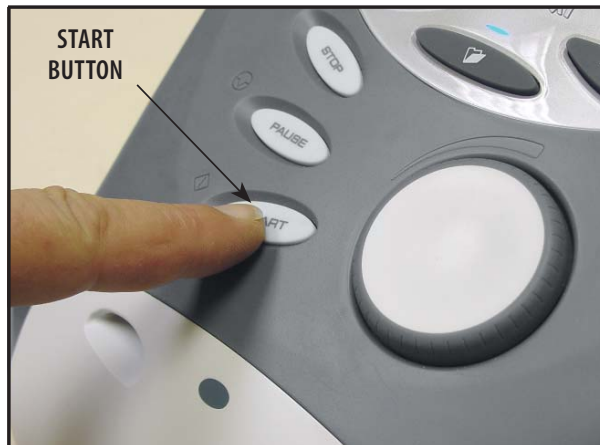

### Pausing Treatment

Press the Pause button to pause therapy session and maintain remaining time. To resume treatment, press the Pause button again.



### Stopping Treatment

To Stop treatment, press the Stop button once. Treatment will stop and the Completed Treatment Review screen will display.



### Erasing Patient Data Card

Refer to page 23 for proper Patient Data Card Erasing instructions.





# OPERATION

## CREATING USER PROTOCOLS

### General Information

This library is a series of protocols created by the user and stored in the system memory. The following information gives general instructions as to setting up, saving and accessing User Protocols. Should the Default Protocols be restored, through the User Utilities, all User Protocols will be permanently removed from the system.

The Therapy System memory will accommodate up to 200 user defined protocols.

### Selecting Modality

Press the button beside the desired modality on the Home screen or select a User Protocol using the Clinical Resources Library button.

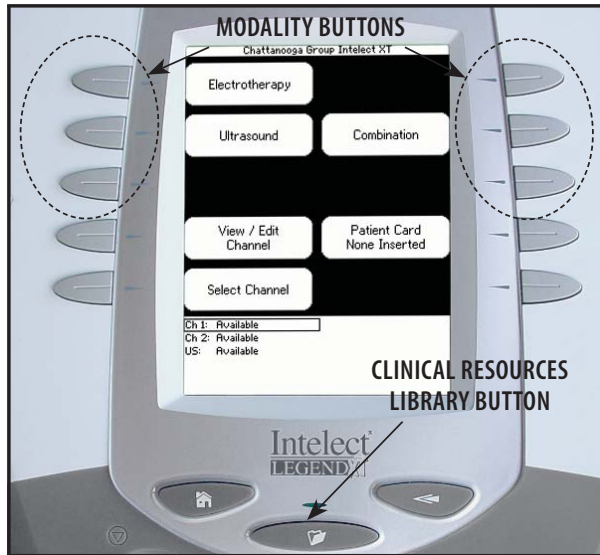

### Editing Modality Parameters

Press the modality Edit button (usually in the lower right corner of the modality Treatment Review screen) and edit as prescribed.

Refer to respective sections of this manual for the specific modality prescribed.

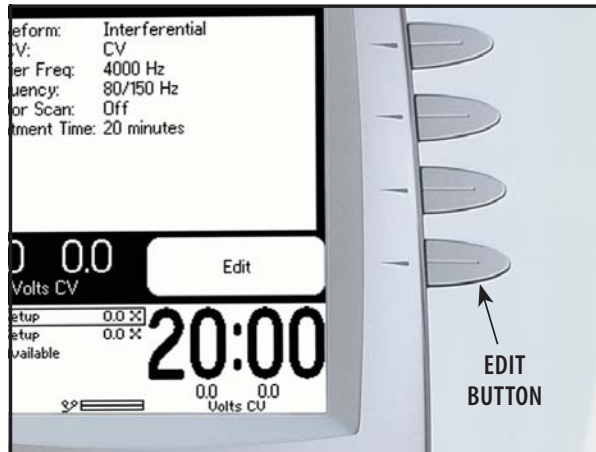

### Selecting Clinical Resources Library

Press the Clinical Resources Library button to begin the save process of the new User Protocol.

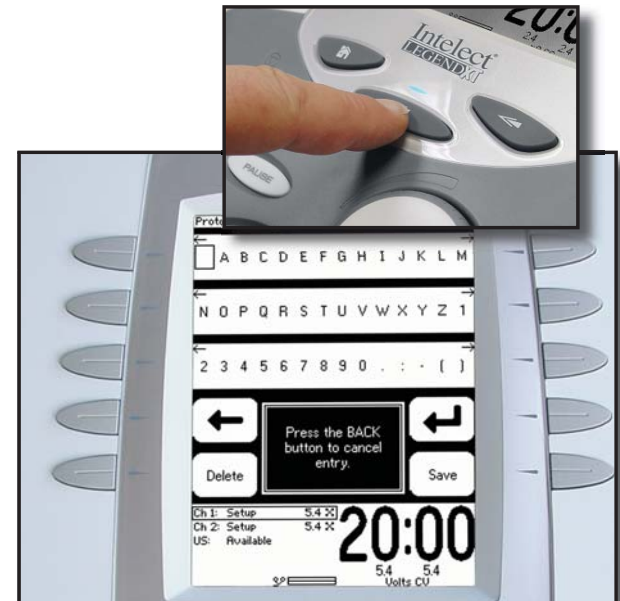



# OPERATION

## CREATING USER PROTOCOLS (CONTINUED)

### Entering User Protocol Name

Select the row of alpha or numeric characters desired by pushing the button beside the corresponding row. Select the desired character in the row by pressing the row button until the desired letter is framed.

When the desired character is framed, press the Accept and Return Arrow button. The character selected will display in the top of the screen and the cursor will advance to the next position.

To move back a character, press the Left Arrow button.

To delete a character, press the Left Arrow button until the character to be deleted is framed. Press the Delete button.

To discard entire entry, press the Back button.

Repeat this procedure until the desired Patient ID is entered.

After Patient ID is entered, press the Save button.

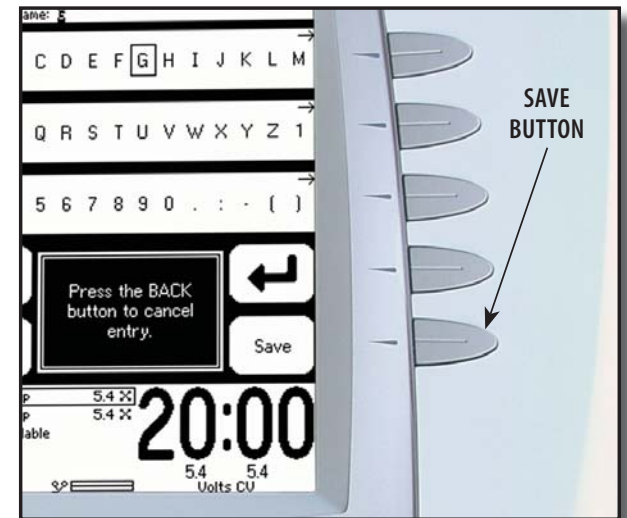
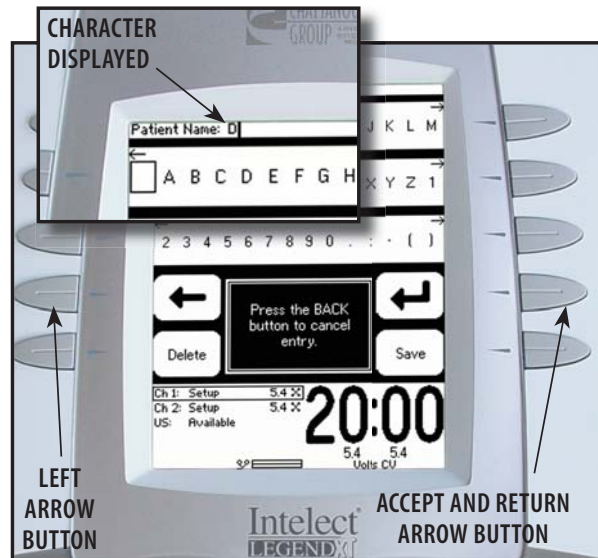
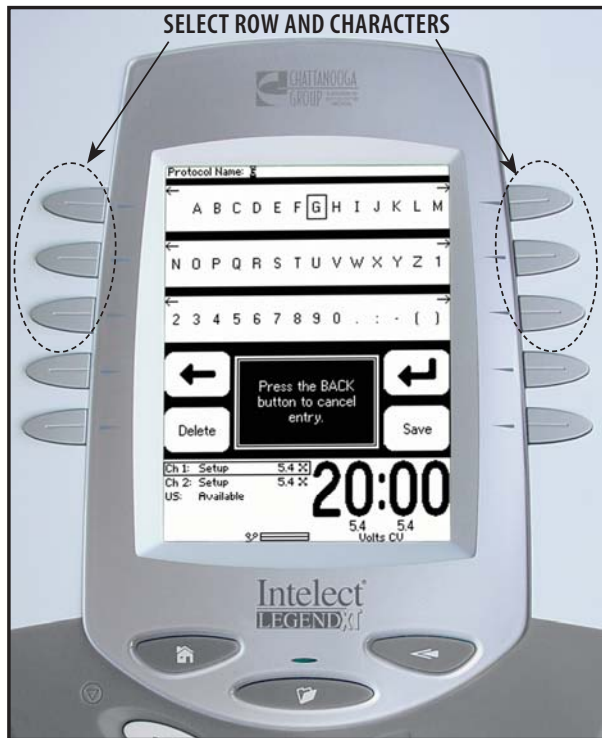

**NOTE:** To add a space, select the area to the left of the letter A.





# OPERATION

## DELETING USER PROTOCOLS

### General Information

The following information provides instructions for the deletion of one User Protocol at a time. Once any single User Protocol is deleted, it cannot be recovered. Should the Default Protocols be restored through the User Utilities, all User Protocols will be permanently removed from the system.

There is no method for recovery of the User Protocols nor can they be saved to any other medium.

### Selecting Clinical Resources Library

Press the Clinical Resources Library button. Then press the User Protocols button.

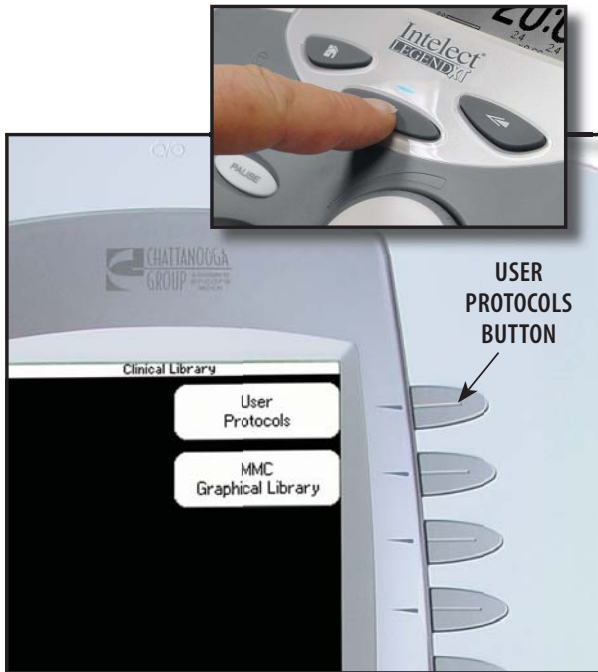

### Selecting User Protocol to Delete

Press the UP and Down Arrow buttons until the desired User Protocol to delete is highlighted.

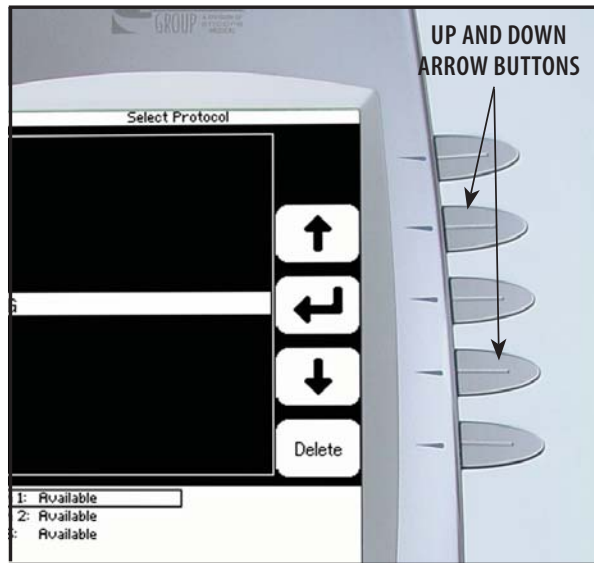

### Deleting User Protocol

Press the Delete button to delete highlighted User Protocol.

A verification screen will appear. Press Yes button to delete protocol or No button to keep protocol.

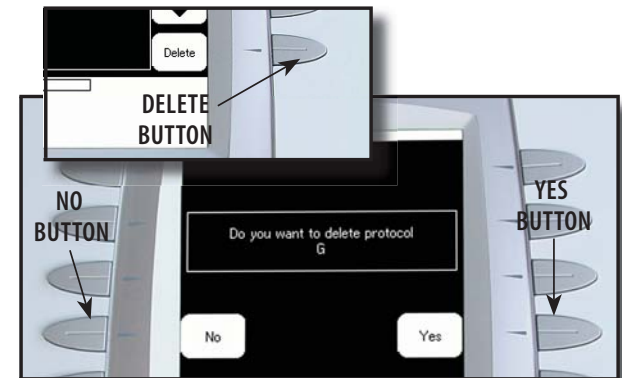

Repeat this process until all desired User Protocols are deleted.

Press the Home button to return to the Home screen.







# OPERATION

## USING USER PROTOCOLS

### Accessing User Protocols

Press the Clinical Resources Library button.  
Press the User Protocols button.

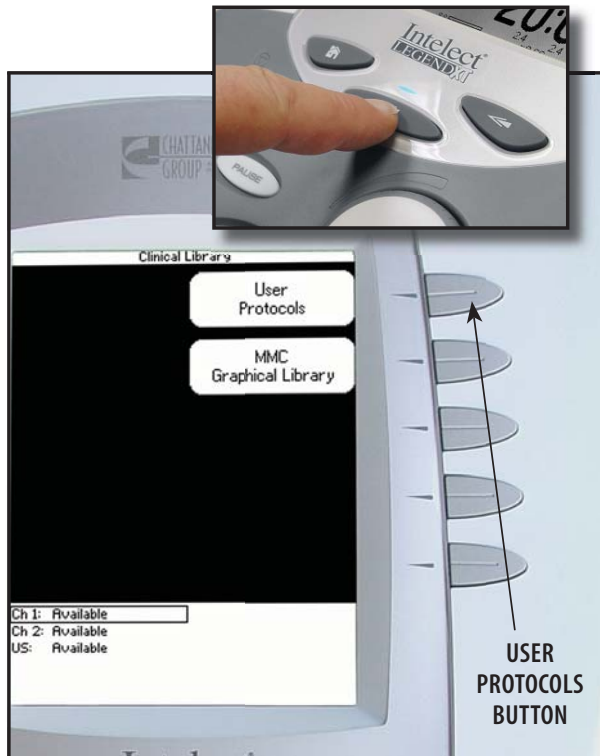

### Selecting User Protocol

Press the UP and Down Arrow buttons until the prescribed User Protocol is highlighted.  
Press the Accept and Return Arrow button.

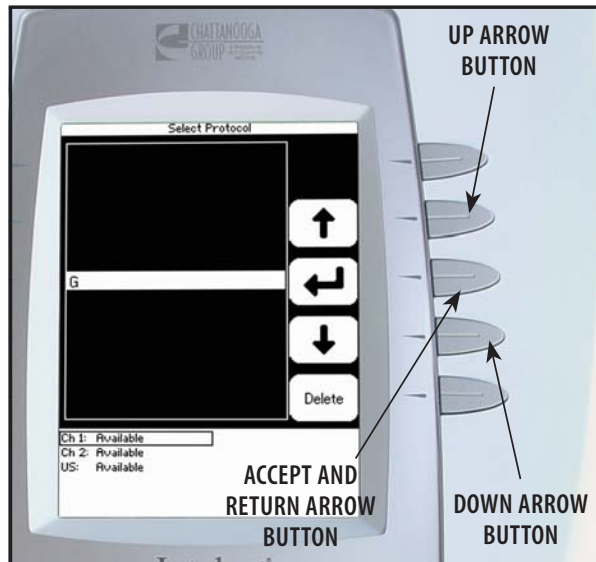

### Preparing Patient

Refer to pages 27 through 30 for Electrotherapy and page 31 for Ultrasound patient preparation instructions.

### Editing Modality Parameters

Press the Edit button.

Edit modality parameters as prescribed.  
Refer to page 35 for Electrotherapy modalities and page 39 for Ultrasound.

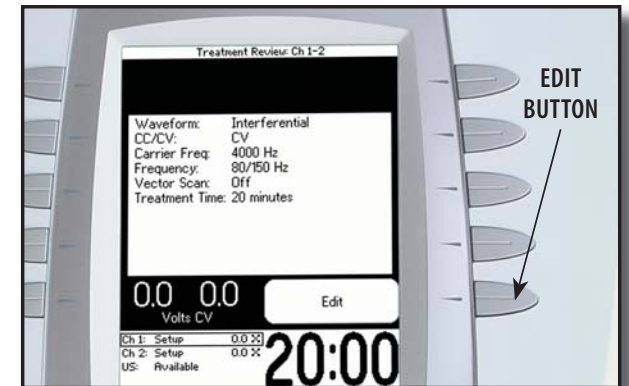





# OPERATION

## USING USER PROTOCOLS (CONTINUED)

### Using Optional Patient Interrupt Switch

Make certain the Patient Interrupt Switch, for the channel(s) being used, is connected to the Therapy System. **Refer to page 13** for Symbol Definitions.

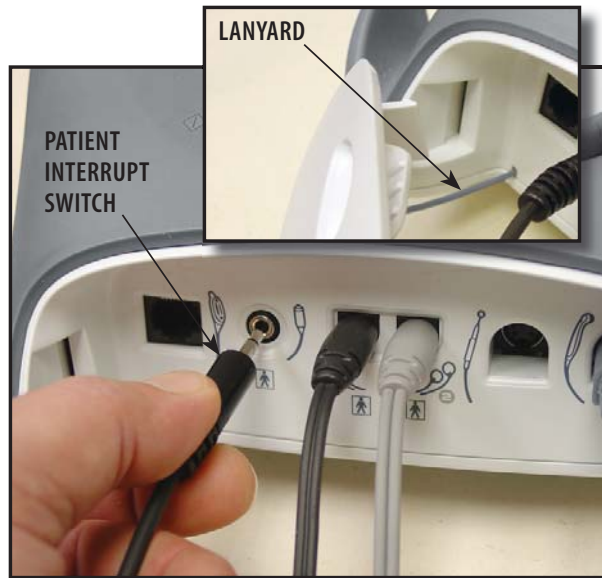

**NOTE:** When reinstalling the Front Access Panel, make certain the Lanyard does not become kinked.

Give Patient Interrupt Switch to patient and explain that pressing the Red button once pauses the therapy session.



If Patient Interrupt Switch is depressed, the treatment will be paused and a message will appear on the System screen.

Press any button to clear the message.

**NOTE:** If the Patient Interrupt Switch is depressed a second time, the message will clear from the screen and the treatment will remain paused.

### Setting Modality Intensity

Set intensity by rotating the Intensity Control Knob to the prescribed level.



### Intensity Knob Rotation

**Clockwise-** Increases Intensity

**Counterclockwise-** Decreases Intensity





# OPERATION

## USING USER PROTOCOLS (CONTINUED)

### Starting Treatment

Press the Start button to begin therapy session.

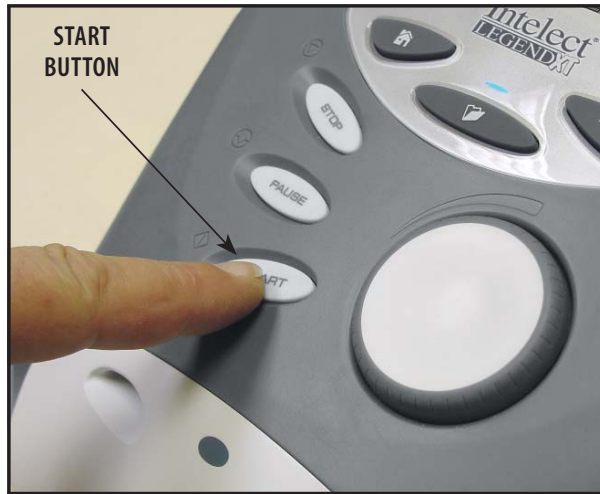

**NOTE:** Modality parameters may be edited at any time during the therapy session. **Refer to page 48 for Electrotherapy and page 52 for Ultrasound.**

### Pausing Treatment

Press the Pause button to pause therapy session and maintain remaining time. To resume treatment, press the Pause button again.



### Stopping Treatment

To Stop treatment, press the Stop button once. Treatment will stop and the Completed Treatment Review screen will display.



### **Saving to Patient Data Card**

After session is complete, press the Save to Patient Card button. **Refer to pages 48 through 57** for Patient Data Card Setup and use.

TOC





# INSTALLATION/REMOVAL

## INSTALLING THE CHANNEL 3/4 ELECTROTHERAPY AND NiMH BATTERY MODULE

### Possible System Configurations

The Intelect Legend XT Electrotherapy and Combination Systems allow installation of optional modality modules by the user. Specifically designed for use with the Intelect Legend XT Therapy Systems, these modules configure the Therapy System to meet many of the therapeutic needs that a clinician may have. The following is a list of possible configurations of the Intelect Legend XT Therapy System.

- Four Channel Electrotherapy or Combination System: Install the Channel 3/4 Electrotherapy Module to the Two Channel Electrotherapy or Combination System.
- Battery Powered Two Channel Electrotherapy or Combination System: Install the NiMH Battery Module.

**NOTE:** The Battery Module cannot be installed on a Four Channel System. The Channel 3/4 Electrotherapy must first be removed.

The Channel 3/4 Electrotherapy and NiMH Battery modules are shipped with all necessary lead wires and accessories in order to complete the installation and allow immediate use by a physician or licensed practitioner.

No special tools or equipment are required for optional Module installation. The System is programmed to automatically recognize the new Module(s), therefore, no software installation is required.

This section explains user installation procedures for the following modules: Channel 3/4 Electrotherapy Module and NiMH Battery Module.





# INSTALLATION/REMOVAL

## INSTALLING THE CHANNEL 3/4 ELECTROTHERAPY AND NiMH BATTERY MODULE (CONTINUED)

### Nomenclature- Channel 3/4 Electrotherapy Module

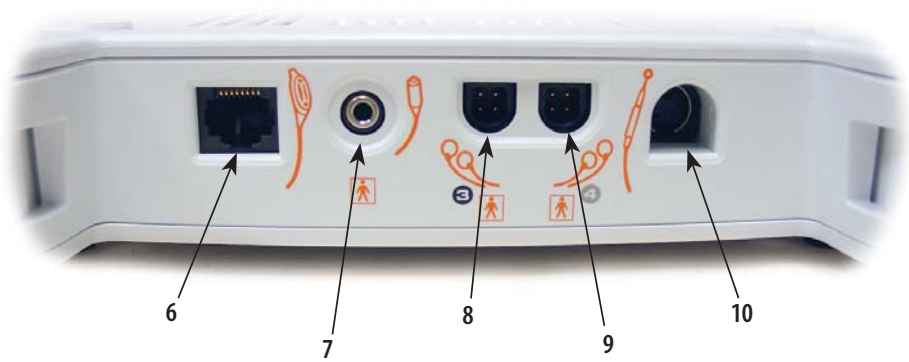
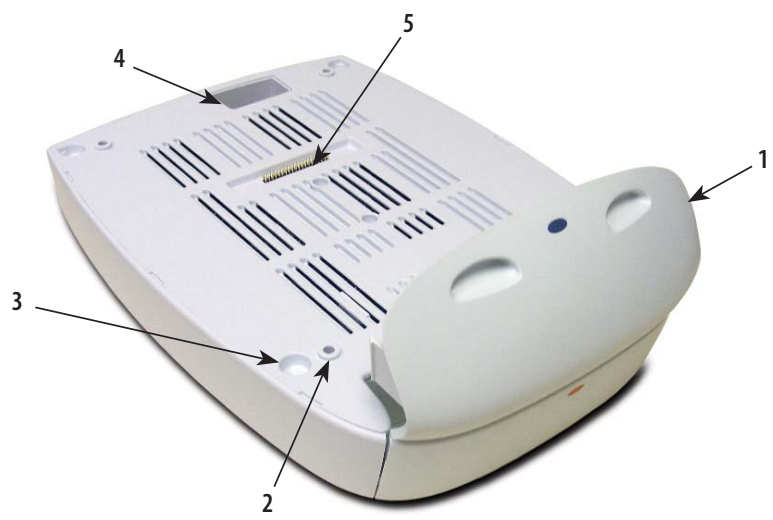

1. Extended Front Access Panel
2. Module to System Mounting Holes
3. Module to System Feet Alignment Indents
4. Power Cord Routing Port
5. Module to System Connector
6. Operator Remote Control Connector\*
7. Patient Interrupt Switch Connector\*
8. Channel 3 Lead Wire Connector\*
9. Channel 4 Lead Wire Connector\*
10. Microcurrent Probe Connector\*

#### Also Included:

- Four 4 mm X 20 mm mounting screws
- Channel 3 and 4 Lead Wires
- Sample of DURA-STICK™ II electrodes

\* Refer to page 13 for Symbol Definitions.





# INSTALLATION/REMOVAL

## INSTALLING THE CHANNEL 3/4 ELECTROTHERAPY AND NiMH BATTERY MODULE (CONTINUED)

### Specifications

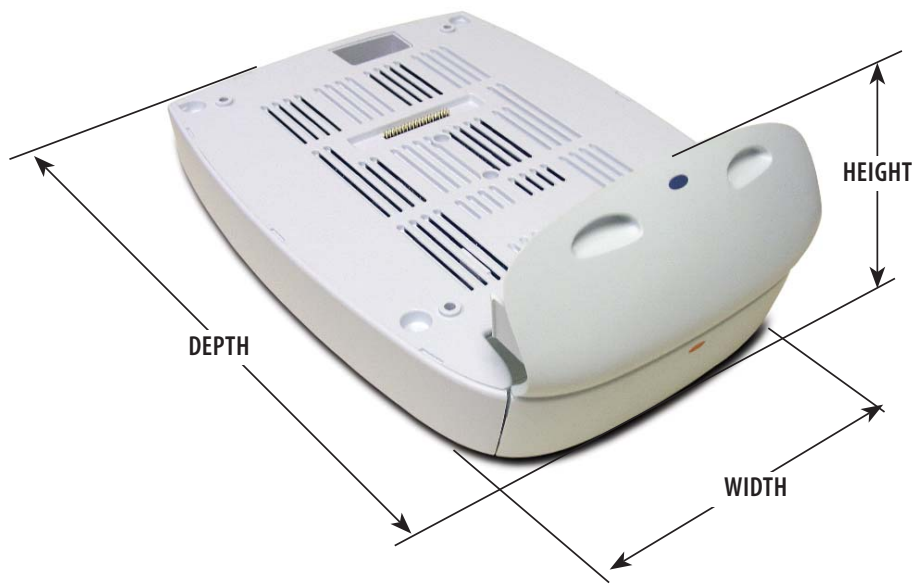

### DIMENSIONS

- Width** ..... 8.250 in (21 cm)
- Depth** ..... 11.875 in (30 cm)
- Height** ..... 4.500 in (11.5 cm)

### WEIGHT

Standard Weight..... 1.0 lbs (.50 kg)

### POWER

- Input.....System Dependent
- Output.....System Dependent
- Electrical Class.....CLASS I
- Electrical Type.....TYPE BF 

### Regulatory Compliance

- UL/IEC/EN 60601-1
- IEC 60601-2-10

**NOTE:** All waveforms except High Voltage Pulsed Current (HVPC) of the Intelect Legend XT Therapy System have been designed with a 200 mA current limit. TENS waveform output intensities are measured, specified and listed to peak, not peak to peak.

### Waveform & Current Specifications

All waveform/currents available to the Intelect Legend XT Therapy System are available to the Channel 3/4 Electrotherapy Module once installation is complete. **Refer to pages 16 through 18** for available waveform specifications.







# INSTALLATION/REMOVAL

## INSTALLING THE CHANNEL 3/4 ELECTROTHERAPY AND NIMH BATTERY MODULE (CONTINUED)

### Disconnecting Mains Power

#### **WARNING**

Disconnect the system from the power source (outlet or remove battery module if installed) before attempting any maintenance, installation, removal, or replacement procedures to prevent electrical shock and possible damage to the system.

Disconnect the Mains Power Cord from the power supply. Remove the Rear Access Panel and disconnect the Mains Power Cord from the Therapy System.



### Removing Lead Wires and Accessories

Remove the Front Access Cover and disconnect the Lead Wires and Accessories from the Therapy System.



### Removing Therapy System from Cart

Remove the Therapy System from the Therapy System Cart, if equipped. Refer to **pages 78 through 79** for proper instructions.

Place Therapy System face down on a clean working surface protected with a soft, clean fabric to prevent damage to the lens.





# INSTALLATION/REMOVAL

## INSTALLING THE CHANNEL 3/4 ELECTROTHERAPY AND NiMH BATTERY MODULE (CONTINUED)

### Releasing Ribbon Cable

Remove and discard the vinyl label holding the Ribbon Cable in the cavity on the Therapy System.

Carefully unroll the Ribbon Cable, making certain not to disconnect it from the Therapy System.

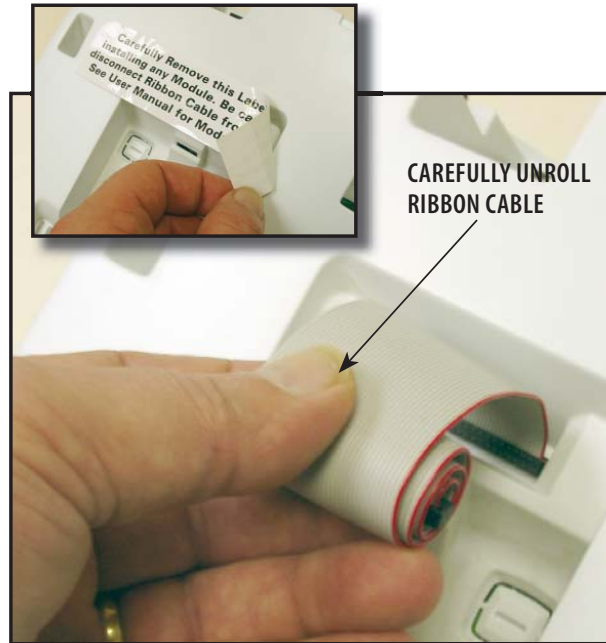

### Positioning Therapy System and Module

Position Therapy System and the Channel 3/4 Electrotherapy Module as shown.



### Connecting Ribbon Cable

Carefully align the Ribbon Cable Connector to the Module Connector Pins and press down to connect.

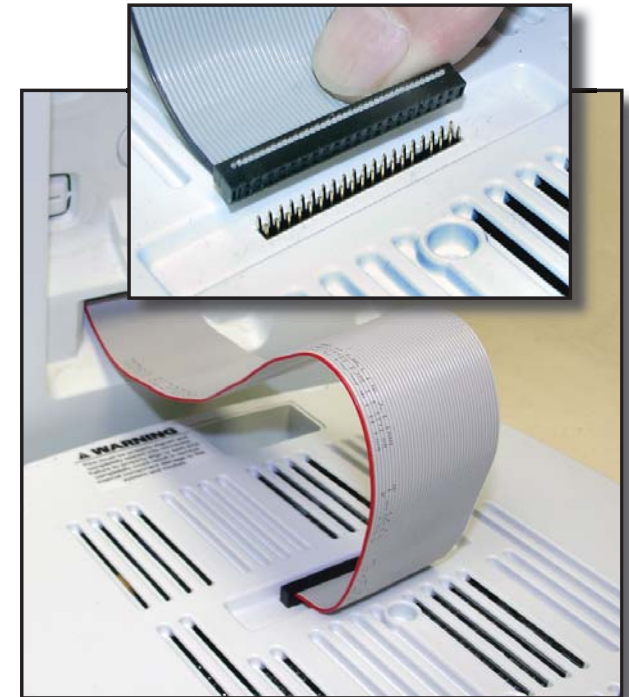

**NOTE:** Ribbon Cable must be connected as shown!

Make certain Ribbon Cable is completely seated to Module Connector Pins.





# INSTALLATION/REMOVAL

## INSTALLING THE CHANNEL 3/4 ELECTROTHERAPY AND NiMH BATTERY MODULE (CONTINUED)

### CAUTION

Do not twist Ribbon Cable. If power is applied to the system with misalignment of pins or a twisted ribbon cable, the controlling electronics in the Module will be destroyed and possible damage to the System's internal components could occur.

### Securing Therapy System to Module

Carefully place the Therapy System and Module on one side. With a #1 Phillips Screwdriver, install the four 4 mm x 20 mm screws.

Tighten screws until the Module does not move on the Therapy System.

### Attaching the Lanyard

With a #1 Phillips Screwdriver, remove the screw retaining the existing Front Access Panel.

Install Lanyard to the new Extended Front Access Panel using the same screw.

### Setting Therapy System onto Module

Set the Therapy System on the Module. Make certain the Feet of the Therapy System are resting in the Module Indents.





# INSTALLATION/REMOVAL

## INSTALLING THE CHANNEL 3/4 ELECTROTHERAPY AND NiMH BATTERY MODULE (CONTINUED)

### Installing Lead Wires and Accessories

Install Lead Wires and additional accessories to Front Panel. **Refer to page 13** for Symbol Definitions.



### Installing Front Access Panel

Install the new Extended Front Access Panel onto Therapy System.

Make certain Lanyard does not become kinked.

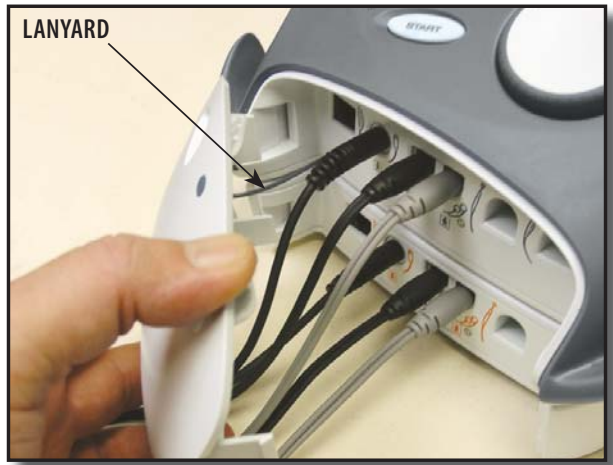

### Mounting to Therapy System Cart

If mounting Therapy System to a Therapy System Cart, **refer to pages 78 through 79** for instructions.

### Connecting Mains Power

Connect the Mains Power Cord to the Therapy System.

Install Rear Access Panel.

Connect the Mains Power Cord to an approved power source.







# INSTALLATION/REMOVAL

## INSTALLING THE CHANNEL 3/4 ELECTROTHERAPY AND NiMH BATTERY MODULE (CONTINUED)

### Turning Therapy System On

Turn the System On using the On/Off Switch. The System will automatically recognize the added Module and display a configuration change message.

Read and carefully follow the instructions on the screen.

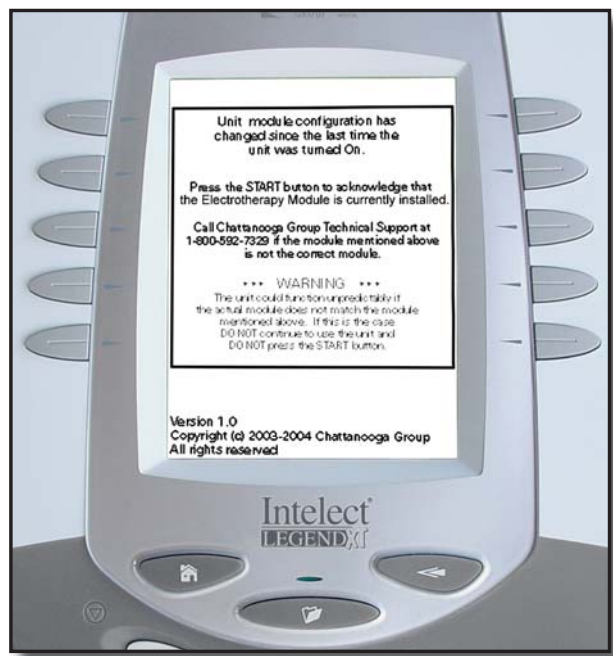

**! WARNING**

Verify that the Module installed is the Module displayed in the message BEFORE pressing the START button. If it is not, DO NOT press the START button. Turn the System OFF and back ON. If the problem continues, call the selling dealer or Chattanooga Group Technical Support immediately.

DO NOT USE THE SYSTEM until all necessary repairs are made by a Technician certified by Chattanooga Group. If use is attempted before repairs are made, the System may operate unpredictably and has the potential of causing injury to the patient or damage to the System's internal components.







# INSTALLATION/REMOVAL

## REMOVING THE CHANNEL 3/4 ELECTROTHERAPY AND NiMH BATTERY MODULE

### Disconnecting Mains Power

**! WARNING**

DISCONNECT THE SYSTEM FROM THE POWER SOURCE (OUTLET OR REMOVE BATTERY MODULE IF INSTALLED) BEFORE ATTEMPTING ANY MAINTENANCE, INSTALLATION, REMOVAL, OR REPLACEMENT PROCEDURES TO PREVENT ELECTRICAL SHOCK AND POSSIBLE DAMAGE TO SYSTEM.

Disconnect the Mains Power Cord from the power supply. Remove the Rear Access Panel and disconnect the Mains Power Cord from the Therapy System.



### Removing Lead Wires and Accessories

Remove the Front Access Cover and disconnect the Lead Wires and Accessories from the Therapy System and Channel 3/4 Electrotherapy Module.



**NOTE:** Keep Lead Wires and accessories for later re-installation to the Therapy System.

### Removing Therapy System from Cart

Remove the Therapy System from the Therapy System Cart, if equipped. Refer to pages 78 through 79 for proper instructions.

Place Therapy System face down on a clean working surface protected with a soft, clean fabric to prevent damage to the lens.





# INSTALLATION/REMOVAL

## REMOVING THE CHANNEL 3/4 ELECTROTHERAPY AND NiMH BATTERY MODULE (CONTINUED)

### Removing Screws Securing Module

With a #1 Phillips Screwdriver, remove the four 4 mm x 20 mm screws securing the Module to the Therapy System.



### Disconnecting Ribbon Cable at Module

Separate the Module from the Therapy System and disconnect the Ribbon Cable from the Module Connector Pins.

**! CAUTION**

Do not disconnect Ribbon Cable from the Therapy System.

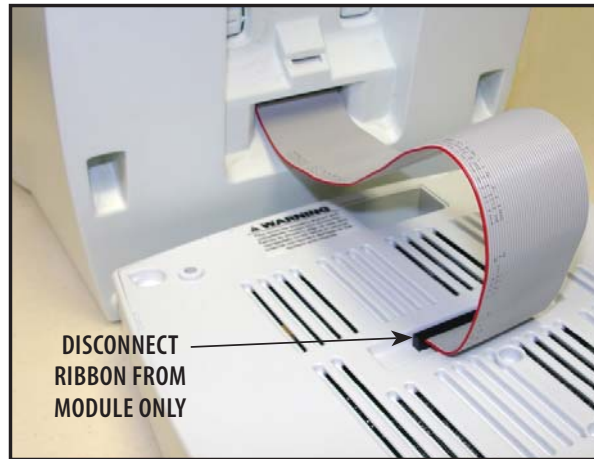

### Storing and Securing Ribbon Cable

Roll the Ribbon Cable up and store in the cavity of the Therapy System. Secure Ribbon Cable with a nonpermanent adhesive tape.





# INSTALLATION/REMOVAL

## REMOVING THE CHANNEL 3/4 ELECTROTHERAPY AND NiMH BATTERY MODULE (CONTINUED)

### Attaching the Lanyard

With a #1 Phillips Screwdriver, remove the screw retaining the existing Front Access Panel.

Install Lanyard to the original Front Access Panel using the same screw.



### Installing Lead Wires and Accessories

Re-install Lead Wires and Accessories to the Therapy System Front Panel.



**NOTE:** When re-installing the Front Access Panel to the Therapy System, make certain the Lanyard does not become kinked.

### Connecting Mains Power

Connect the Mains Power Cord to the Therapy System.

Install Rear Access Panel.

Connect the Mains Power Cord to an approved power source.





# INSTALLATION/REMOVAL

## REMOVING THE CHANNEL 3/4 ELECTROTHERAPY AND NiMH BATTERY MODULE (CONTINUED)

### Turning Therapy System On

Turn the System On using the On/Off Switch. The System will automatically recognize the Module has been removed and will display a configuration change message.

Read and carefully follow the instructions on the screen.

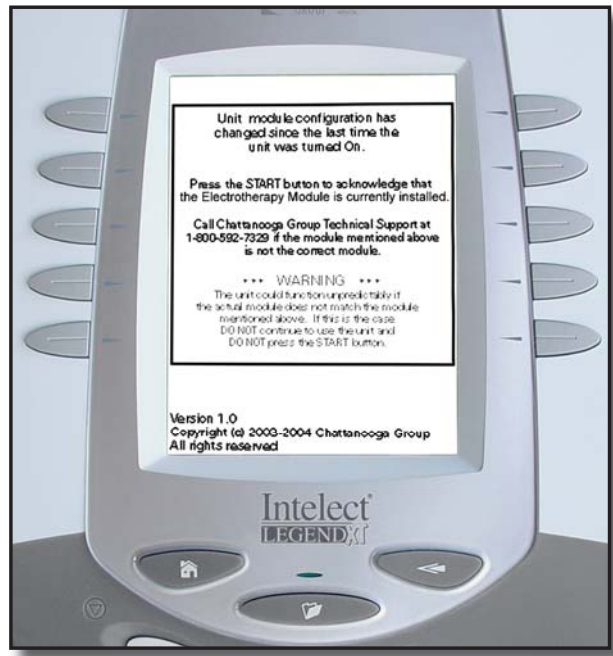

**WARNING**

Verify that the Module installed is the Module displayed in the message BEFORE pressing the START button. If it is not, DO NOT press the START button. Turn the System OFF and back ON. If the problem continues, call the selling dealer or Chattanooga Group Technical Support immediately.

DO NOT USE THE SYSTEM until all necessary repairs are made by a Technician certified by Chattanooga Group. If use is attempted before repairs are made, the System may operate unpredictably and has the potential of causing injury to the patient or damage to the System's internal components.







# INSTALLATION/REMOVAL

## GENERAL INFORMATION- OPERATOR REMOTE

The Optional Operator Remote is designed for use with the Intelect Legend XT Electrotherapy and Combination Systems only and allows the operator to control the application of manual muscle stimulation therapy as well as increase and decrease the waveform intensity.

There are two different Operator Remotes. One is designed for use with Channels 1 and 2. It is designated by a blue Pause Button on the control. The other is designed for use on channels 3 and 4 (Systems with the optional Channel 3/4 Electrotherapy Module installed) and is designated with an orange color Pause Button. Make certain the remote for the channels being used is connected to the respective System or Module before administering any therapy with the Operator Remote.

### Installing the Operator Remote

1. Remove the Front Access Panel.



2. Connect the Operator Remote into its respective jack.



**NOTE:** If the System is equipped with the Channel 3/4 Electrotherapy Module, the Channel 3/4 User remote will be installed into the respective jack on the Module.

**CAUTION**

Operator Remote is to be used under supervision of a physician or licensed practitioner only. The Operator Remote is not intended for patient use.

3. Reinstall the System Front Access Panel.







# INSTALLATION/REMOVAL

## GENERAL INFORMATION- THERAPY SYSTEM CART

The optional Therapy System Cart is designed for use with the Intelect Legend XT Electrotherapy and Combination Systems only and allows the user to easily transport the System from patient to patient within the clinic as well as store all necessary accessories, supplies and applicators used for the various modalities of the System.

The following instructions will explain the proper installation of the Intelect Legend XT Therapy System, with and without optional modules, to a Therapy System Cart.

### Nomenclature

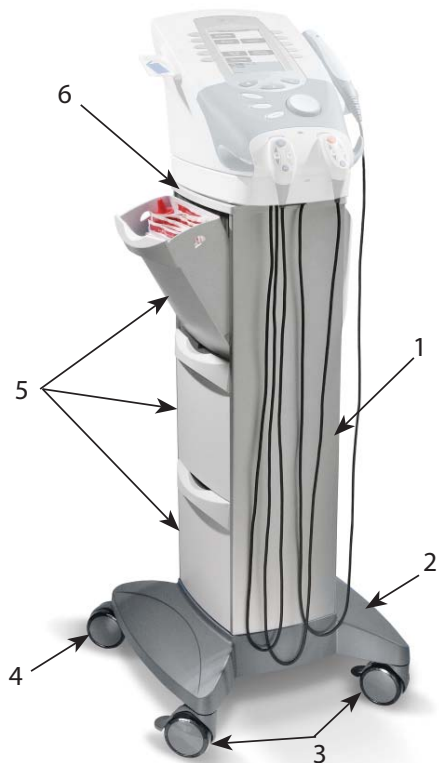

1. Front and Rear Extrusion
2. Cart Base
3. Front Locking Swivel Casters (2)
4. Rear Swivel Casters (2)
5. Removable Storage Bins (6)
6. Cart Top

### Specifications

#### Dimensions

##### Height

- Cart Only ..... 33.75 in (85.7 cm)
- With System ..... 42.50 in (108 cm)
- With System and Module ..... 44.25 in (112.4 cm)

Width ..... 17 in (43.2 cm)

Depth ..... 16.25 in (41.3 cm)

Standard Weight ..... 24 lbs (10.9 kg)

Shipping Weight ..... 33 lbs (15.0 kg)

Power Required . . . 100 - 240 V, 50/60 Hz

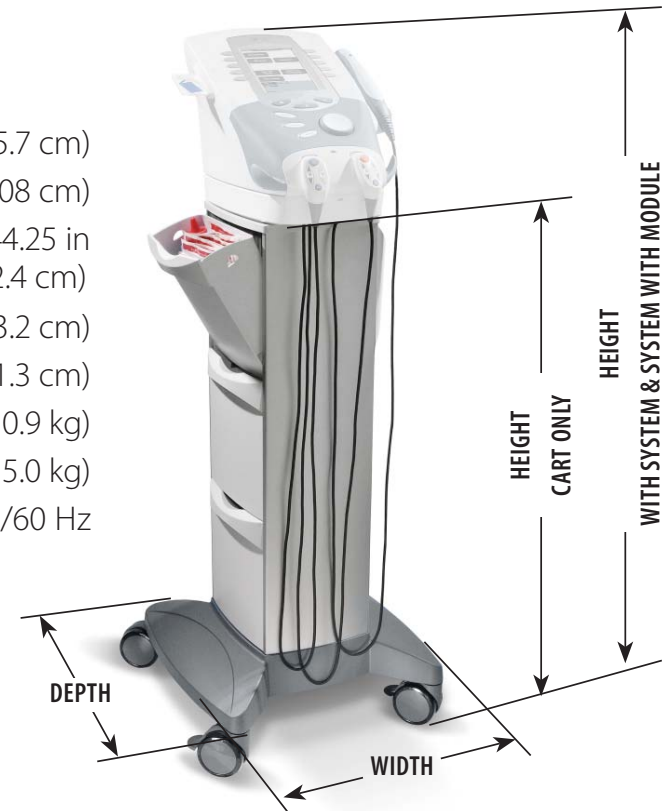



# INSTALLATION/REMOVAL

## MOUNTING THERAPY SYSTEM TO THERAPY SYSTEM CART

### Assembling the Therapy System Cart

Follow the "Assembling Therapy System Cart" instructions shipped with the Cart for proper assembly. If the instruction sheet is not available visit the Chattanooga Group website, [www.chattanooga.com](http://www.chattanooga.com), to obtain a copy of the instruction sheet.

### Preparing the Therapy System Cart

Remove all the Storage Bins from both sides of the Therapy System Cart by pulling each bin out and up.

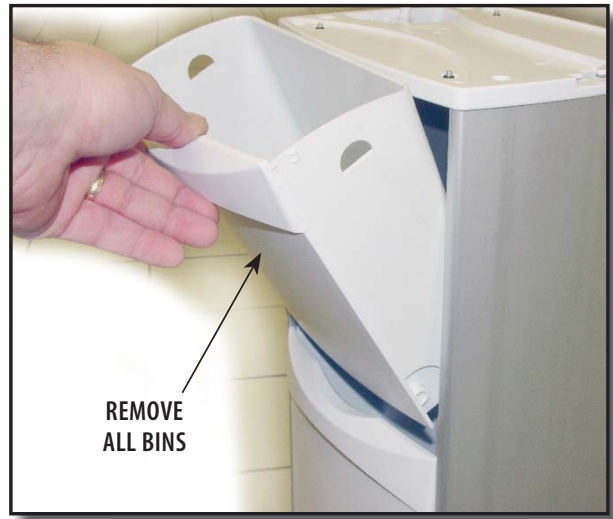

Allow approximately 4.5 in (11.5 cm) of the power cord extending through the top of the cart for connecting to system. If the system is equipped with an optional NiMH Battery, Laser or Channel 3/4 Electrotherapy Module, it will be necessary to allow 6.5 in (16.5 cm) of the Power Cord extending through the top of the Therapy System Cart.

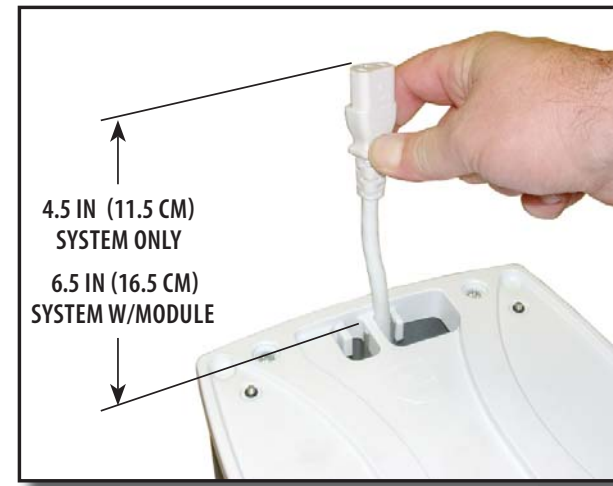

### Mounting the Therapy System to Cart

Position the Therapy System onto the Therapy System Cart with the rear of the System over the Mains Power Cord.

Secure the System to the cart with the four socket head screws in the Therapy System Cart Top.

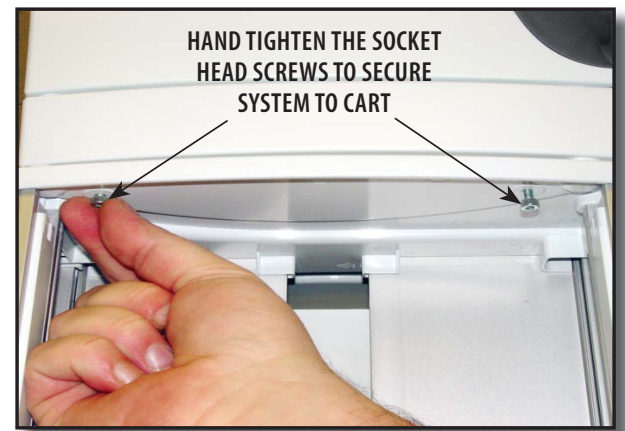

**NOTE:** Secure the System to the cart by tightening the screws by hand only. Do not use a wrench to tighten the screws. Overtightening may cause damage to the System or Module housing.





# INSTALLATION/REMOVAL

## MOUNTING THERAPY SYSTEM TO THERAPY SYSTEM CART (CONTINUED)

### Connecting Mains Power

Plug Power Cord into the System Mains Disconnect and reinstall the Rear Access Panel. Install all lead wires and cables to the System.



### Installing Storage Bins

Install Storage Bins into Therapy System Cart. Start with bottom Storage Bin first.



### Removing System from Therapy System Cart

To remove the Therapy System from the Therapy System Cart, repeat the Mounting instructions.



# OPTION OPERATION

## USING THE OPERATOR REMOTE

### Nomenclature



1. Remote Storage Hook
2. Treatment Pause Button
3. Channel 2 Increase Intensity Button
4. Channel 2 Decrease Intensity Button
5. Manual Stimulation Button
6. Channel 1 Decrease Intensity Button
7. Channel 1 Increase Intensity Button

**NOTE:** Refer to page 13 for Symbol Definitions.

### Operation

**CAUTION**

Operator Remote is to be used under supervision of a physician or licensed practitioner only.

The Operator Remote is not intended for patient use.

Install the Operator Remote as described on [page 76](#). Set up electrotherapy session as described on [pages 35-37](#).

Start electrotherapy session by pressing the Start Treatment Button.



Pause session by pressing the Pause Button on the Remote being used.

Press the M Button on the remote to apply Manual Stimulation. Release the M Button to stop Manual Stimulation application.

Increase or Decrease the intensity by pressing the Up or Down Button on the Operator Remote for the respective channel being used. This can be done while Manual Stimulation is being applied.

To Stop session, press the Stop Treatment Button.

**WARNING**

Verify each Operator Remote is connected to the applicable jack for the channels being used.



# OPTION OPERATION

## USING THE OPERATOR REMOTE (CONTINUED)

### Storing the Operator Remote

Normal storage of the Operator Remote is on the Front Access Panel of the System. Place the storage hook into one of the Remote Storage Indents as shown.







# OPTION OPERATION

## USING THE THERAPY SYSTEM CART

### Nomenclature

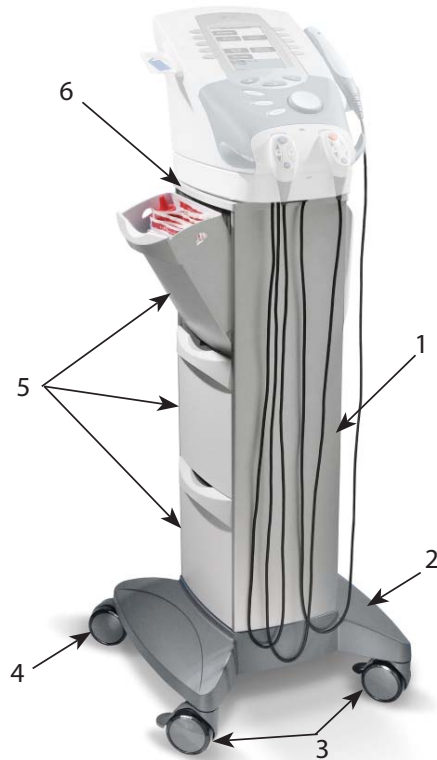

1. Front and Rear Extrusion
2. Cart Base
3. Front Locking Swivel Casters (2)
4. Rear Swivel Casters (2)
5. Removable Storage Bins (6)
6. Cart Top

**⚠ WARNING**

Make certain the unit is electrically grounded by connecting only to a grounded electrical service receptacle conforming to the applicable national and local electrical codes.

### Operation

1. Install the Therapy System Cart as described on pages **78 through 79**.
2. Open Storage Bins and place items for storage. Close Bins until they snap into position.



3. Lock the Front Locking Swivel Casters by pushing Lock down with toe of shoe. Unlock by pulling Lock up with toe of shoe.

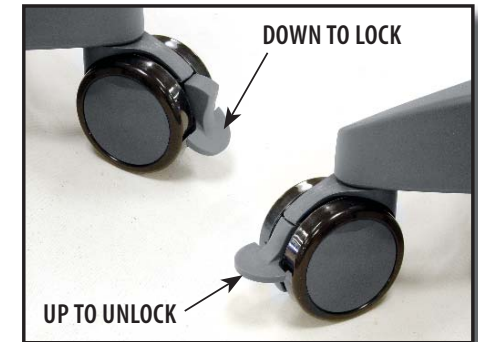

# OPTION OPERATION

## USING THE NIMH BATTERY MODULE

The Intellect Legend XT Battery Module allows easy upgrade of the Intellect Legend XT Electrotherapy and Combination Systems to create a battery powered Therapy System. The information in this section instructs the owner, operator or user as to the initial setup and operation of the optional NiMH Battery Module. No additional Software is required for the Module as the System automatically recognizes its presence and activates all necessary software inherent in the System.

Read, understand and follow all Safety Precautions on **pages 2 through 9** and throughout this manual before operating this Therapy System, Modules or Accessories.

### Nomenclature

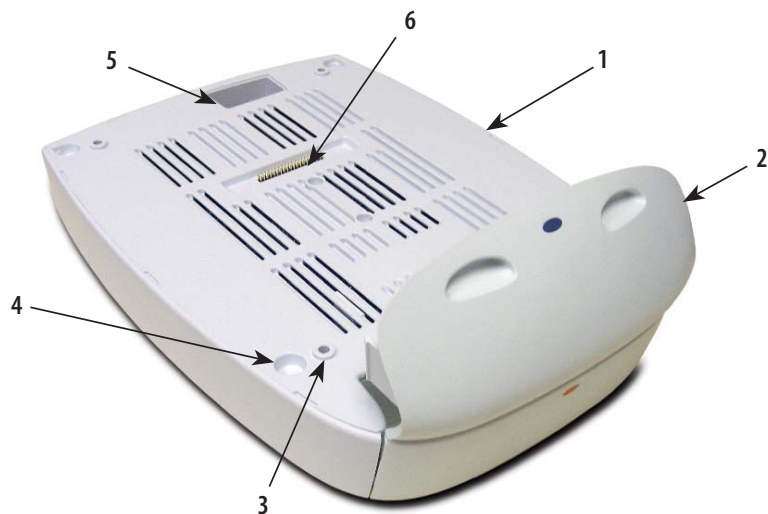

1. Battery Module
2. Extended Front Access Panel
3. Module to System Mounting Holes
4. Module to System Feet Alignment Indents
5. Power Cord Routing area
6. Ribbon Cable Connector



# OPTION OPERATION

## CHARGING BATTERY MODULE

Use the following instructions to properly charge the Intelect® Legend XT Battery Module for use.

### When to Recharge

Charging of the Battery Module is required when the Battery Indicator begins flashing.

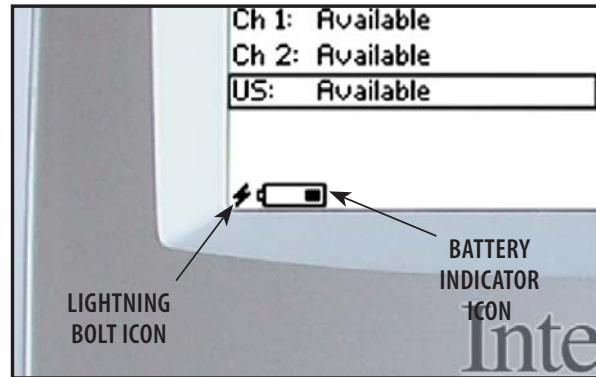

**NOTE:** The Lightning Bolt icon will continue to display as long as the System is connected to a power source.

**! WARNING**

When charging Battery Module, make certain the System is electrically grounded by connecting only to a grounded electrical service receptacle conforming to the applicable national and local electrical codes. Using any other power source will cause extensive damage to internal components and render the System unsafe for patient therapy.

**! DANGER**

- Charge the battery according to the instructions found in this manual. Never attempt to charge the battery on any other charging mechanism.
- Use the Battery Module only with the Intelect Legend XT Therapy System.
- Do not reverse the polarity of the Battery Module. Doing so can increase the individual cell temperature and cause cell rupture or leakage.

### Charging Temperature

- Charging efficiency is optimum within a temperature range of 50 °F to 86 °F (10 °C to 30 °C). Charge the Battery Module within this temperature range.
- At temperatures below 32 °F (0 °C) the gas absorption reaction is not sufficient and causes an increase of the gas pressure inside the battery. This condition can activate the safety vent and lead to alkaline gas leaking and battery performance deterioration.
- Charging efficiency of the Battery Module drops at temperatures above 104 °F (40 °C) and can disrupt full charging, lead to deterioration in performance and battery cell leakage.

With Battery Module installed on the Intelect Legend XT Therapy System, plug the System into an approved, grounded power outlet.

Turn the System on. The Lightning Bolt icon will display indicating the battery is charging. As the battery charges, the Battery indicator icon will progressively fill until it is solid black indicating full charge.





# OPTION OPERATION

## BATTERY MODULE SERVICE LIFE

Since NiMH Batteries are designed for multiple cycles of charging and discharging, the expected cycle life of the Battery Module is at minimum 500 cycles utilizing proper discharging and charging procedures.

When the service time (use time between charges) of the Battery Module is significantly reduced, the service life of the Battery Module is exceeded and should be replaced with a new Chattanooga Group Battery Module.

Never attempt to rebuild the Battery Module.

Properly dispose of old Battery Module.

## STORING THE BATTERY MODULE

### Short Term Storage

The Battery Module should be operated, transported and stored in temperatures between 59 °F and 104 °F (15 °C and 40 °C), with Relative Humidity ranging from 30%-60%.

### Long Term Storage

For long term storage of the Battery Module, remove the Battery Module from the System and store in temperatures between 59 °F and 104 °F (15 °C and 40 °C), with Relative Humidity ranging from 30%-60%.

When charging the Battery Module for the first time after long term storage, restore the battery service life by charging and discharging the Battery Module several times.

If storing the Battery Module for periods longer than one year, charge the Battery Module at least once per year to prevent performance deterioration and battery leakage due to self-discharge from storage.

# DANGER



• NiMH Batteries contain Class E Corrosive materials. In the event of battery cell rupture or leakage, handle Battery Module wearing neoprene or natural rubber gloves. Contents of a ruptured or leaking battery can cause respiratory irritation. Hypersensitivity to nickel can cause allergic pulmonary asthma. Contents of cell coming in contact with skin can cause skin irritation and/or chemical burns.



• Never, under any circumstances, open the Battery Module housing or cells. Should an individual cell from a battery become disassembled, spontaneous combustion of the negative electrode is possible. There can be a delay between exposure to air and spontaneous combustion.

• Dispose of NiMH batteries according to national, state and local codes and regulations.





# TROUBLESHOOTING

## ERROR CODES

### General Information

The Intellect Legend XT Therapy Systems incorporate error messages, and warnings to inform the user of problems or potential problems with the system, modality, or accessories. These are numbered so the user can possibly correct the problem without the aid of service personnel. Use the following Troubleshooting Charts to define the error codes, and locate the probable cause and possible remedies before contacting the dealer or factory for technical service.

Code Number	Type Message	Probable Cause	Possible Remedies
100	Warning	Overcurrent	<p><b>A.</b> Check Electrodes and Lead Wires. Make certain Lead Wires are not damaged and are properly connected to the system. Make certain Lead Wires are properly connected to the Electrodes and that electrodes are not damaged and are making proper contact with treatment area.</p> <p><b>B.</b> Replace Lead Wires and Electrodes.</p>
101	Warning	Shorted Lead Wires	<p><b>A.</b> Check Electrodes and Lead Wires. Make certain Lead Wires are not damaged and are properly connected to the system. Make certain Lead Wires are properly connected to the Electrodes and that electrodes are not damaged and are making proper contact with treatment area.</p> <p><b>B.</b> Replace Lead Wires and Electrodes.</p>
102	Warning	Bad Contact Quality	<p><b>A.</b> Make certain Electrodes are making proper contact with the treatment area.</p> <p><b>B.</b> Make certain Lead Wires are properly connected to Electrodes.</p> <p><b>C.</b> Replace Electrodes and Lead Wires.</p>
103	Warning	Blank Patient ID	Properly enter Patient ID. Refer to Therapy System User Manual for Patient Data Card instructions.
104	Warning	<ol style="list-style-type: none"> <li>Blank Protocol Name</li> <li>Blank Sequence Name</li> </ol>	Properly enter Protocol or Sequence Name. Refer to the appropriate section of the Therapy System User Manual.
106 107	Warning Warning	<ol style="list-style-type: none"> <li>Attempting to delete factory set Sequence.</li> <li>Attempting to delete Clinical Protocol.</li> </ol>	Cannot delete factory set Clinical Protocols or factory set Sequences.







# TROUBLESHOOTING

## ERROR CODES (CONTINUED)

Code Number	Type Message	Probable Cause	Possible Remedies
108	Warning	Attempting to save additional User Protocols or Sequences after system memory has reached the maximum allowed (200).	Delete some User Protocols or Sequences. Refer to appropriate section of the Therapy System User Manual for instructions.
109 110 111	Warning Warning Warning	Attempting to access protocols and none are found in the system.	<b>A.</b> User Protocols- No protocols have been saved in the system. Refer to Therapy System User Manual to save User Protocols.
112	Warning	Ultrasound Applicator disconnected from system during treatment session.	<b>A.</b> Connect Ultrasound Applicator to system. <b>B.</b> If Ultrasound Applicator is connected, reset system by turning power switch Off and On. <b>C.</b> If problem persists, connect a known good Ultrasound Applicator. If problem continues, contact dealer or Chattanooga Group for service.
113	Warning	Attempting to perform Ultrasound treatment with no Applicator connected to the system.	<b>A.</b> Connect the desired Ultrasound Applicator to the system. <b>B.</b> If Ultrasound Applicator is connected, reset system by turning power switch Off and On. <b>C.</b> If problem persists, connect a known good Ultrasound Applicator. If problem continues, contact dealer or Chattanooga Group for service.
114	Warning	Ultrasound Applicator is not calibrated.	Attempt to use a known good Applicator. If problem continues, contact dealer or Chattanooga Group for service.
115	Warning	Ultrasound Applicator is too hot.	Allow Ultrasound Applicator Sound Head to cool to ambient temperature.
116 117	Warning Warning	<b>1.</b> No Patient Data Card is inserted into the system. <b>2.</b> Attempted to use an Invalid Patient Data Card.	<b>A.</b> Properly insert the Patient Data Card into the system port. Refer to Therapy System User Manual for new and existing Patient Data Card instructions. <b>B.</b> Attempt to use a known good Patient Data Card. <b>C.</b> Make certain only a Patient Data Card is being used. <b>D.</b> If problem continues, contact dealer or Chattanooga Group for service.





# TROUBLESHOOTING

## ERROR CODES (CONTINUED)

Code Number	Type Message	Probable Cause	Possible Remedies
118	Warning	Attempting to save additional User Protocols after system memory has reached the maximum allowed (200).	Delete some User Protocols. Refer to appropriate section of the Therapy System User Manual for instructions.
119	Warning	<b>1.</b> Attempted to read a treatment from Patient Data Card that is not a valid treatment for the system <b>2.</b> Attempted to use a Non-Patient Data Card. <b>3.</b> No Patient Data Card inserted into system port. <b>4.</b> Unknown type of smart card inserted into system.	<b>A.</b> Use a Patient Data Card with proper treatment data for the system. <b>B.</b> Properly insert a Patient Data Card. <b>C.</b> Insert a known good Patient Data Card. <b>D.</b> If problem continues, contact dealer or Chattanooga Group for service.
120	Warning		
121	Warning		
122	Warning		
123	Warning	Patient Data Card is full.	Erase Patient Data Card. Refer to Therapy System User Manual for instructions.
124	Warning	Patient Treatment Data already saved.	<b>A.</b> Cannot save same data again on Patient Data Card. <b>B.</b> Use a new Patient Data Card to resave data. <b>C.</b> Erase Patient Data Card and resave treatment data.
126	Warning	No valid channels are available for attempted treatment.	<b>A.</b> Complete existing treatment before attempting to start another. <b>B.</b> Reset Therapy System by turning main power switch Off and On.
135	Warning	Control Board Software upgrade warning.	Upgrade Control Board Software to latest version. Contact dealer or Chattanooga Group for latest software upgrade and instructions.
136	Warning	Stim Board Main Software upgrade warning.	Upgrade Stim Board Software to latest version. Contact dealer or Chattanooga Group for latest software upgrade and instructions.
137	Warning	Stim Board Main Software upgrade warning.	Upgrade Stim Board Software to latest version. Contact dealer or Chattanooga Group for latest software upgrade and instructions.





# TROUBLESHOOTING

## ERROR CODES (CONTINUED)

Code Number	Type Message	Probable Cause	Possible Remedies
138	Warning	Ultrasound Board Software upgrade warning.	Upgrade Ultrasound Board Software to latest version. Contact dealer or Chattanooga Group for latest software upgrade and instructions.
141	Warning	Battery Module Software upgrade warning.	Upgrade Battery Software to latest version. Contact dealer or Chattanooga Group for latest software upgrade and instructions.
145	Warning	Patient Data Card button on Home screen was pressed with no Patient Data Card installed into system port and no treatment currently being performed.	Properly insert a Patient Data Card, set up and perform the treatment and save data to Patient Data Card.



## WARNING

In the event that an Error message or Warning appears beginning with a 2 or 3, immediately stop all use of the system and contact the dealer or Chattanooga Group for service. Errors and Warnings in these categories indicate an internal problem with the system that must be tested by Chattanooga Group or a Field Service Technician certified by Chattanooga Group before any further operation or use of the system.

Use of a system that indicates an Error or Warning in these categories may pose a risk of injury to the patient, user, or extensive internal damage to the system.





# REPLACEMENT ACCESSORIES

## GENERAL INFORMATION

The following provides the users of the Intelect Legend XT Therapy System the necessary information to order the replacement accessories most commonly used with the System. This list of replacement accessories are designed for use with the Intelect Legend XT Therapy System. When ordering, provide the respective part number, description and quantity desired.

PART NUMBER	DESCRIPTION
2767	Battery Module
2781	Channel 3/4 Electrotherapy Module
2775	Therapy System Cart
2768	Patient Data Management System
27465	Patient Data Card (Pack of 25)
27469	Patient Interrupt Switch (Channel 1 & 2)
27470	Patient Interrupt Switch (Channel 3 & 4)
27312	Electrotherapy Lead Wire- Channel 1
27313	Electrotherapy Lead Wire- Channel 2
27314	Electrotherapy Lead Wire- Channel 3
27315	Electrotherapy Lead Wire- Channel 4

PART NUMBER	DESCRIPTION
27508	Operator Remote- Channels 1 & 2
27079	Operator Remote- Channels 3 & 4
27333	1 cm <sup>2</sup> Ultrasound Applicator
27334	2 cm <sup>2</sup> Ultrasound Applicator
27335	5 cm <sup>2</sup> Ultrasound Applicator (Standard)
27336	10 cm <sup>2</sup> Ultrasound Applicator
27468	Carrying Bag
79977	High Voltage Pulsed Current (HVPC) Probe Kit
79976	Microcurrent Probe Kit
1264	Nylatex® Wrap- 3 pack, 2.5 in X 24 in (6 cm X 61 cm)
72852	Black Rubber Carbon Electrodes- 3 in (8 cm) Round
72853	Red Rubber Carbon Electrodes- 3 in (8 cm) Round
42044	DURA-STICK™ II 2.75 in (7 cm) Electrodes (40/case)
4248	Conductor™ Ultrasound Gel- 9 oz Bottle (24/case)





# MAINTENANCE

## CARING FOR THE THERAPY SYSTEM

### Cleaning the Therapy System

With the system disconnected from the power source, clean the system with a clean, lint free cloth moistened with water and mild antibacterial soap. If a more sterile cleaning is needed, use a cloth moistened with an antimicrobial cleaner.

Do not submerge the system in liquids. Should the unit accidentally become submersed, contact the dealer or Chattanooga Group Service Department immediately. Do not attempt to use a system that has been wet inside until inspected and tested by a Service Technician Certified by Chattanooga Group.

Do not allow liquids to enter the ventilation holes in the optional modules. This could permanently damage the modules.

### Cleaning the Lens

Clean the Therapy System Screen Lens using NOVUS® Polish System. Contact Novus at: [www.novuspolish.com](http://www.novuspolish.com)

## CALIBRATION REQUIREMENTS

### Calibrating Ultrasound Applicators

Annual factory calibration is required for all Ultrasound Applicators. Only the Applicators should be sent to the factory or a Field Technician certified by Chattanooga Group for this procedure.

## FACTORY SERVICE

When the Intellect Legend XT Therapy System or any of the accessory modules require factory service, contact the selling dealer or Chattanooga Group Service Department.

All Therapy System and accessory modules returned to the factory for service must include the following:

### WARRANTY REPAIR/OUT OF WARRANTY REPAIR

1. Written statement containing the following information:
  - RA Number- Obtain from Factory
  - Therapy System or Module Model Number
  - Therapy System or Module Serial Number
  - Contact Person with Phone and Fax Numbers
  - Billing Address (for Out of Warranty Repair)
  - Shipping Address (Where to Ship Unit after Repair)
  - Detailed Description of Problem or Symptoms
2. Copy of original invoice issued at purchase of the Therapy System or Module.
3. Ship the unit to address specified by an authorized service technician.

Service to these units should be performed only by Service Technicians certified by Chattanooga Group.

Ultrasound Applicators require annual calibration, from the date placed in service, by the Factory or a Service Technician certified by Chattanooga Group.





# WARRANTY

Chattanooga Group, a division of Encore Medical, L. P., ("Company") warrants that the Intellect Legend XT Therapy System and Channel 3/4 Electrotherapy Module ("Products") are free of defects in material and workmanship. This warranty shall remain in effect for two years (24 months) from the date of original consumer purchase. If these Products fail to function during the two year warranty period due to a defect in material or workmanship, at the Company's option, the Company or the selling dealer will repair or replace the respective Product without charge within a period of thirty (30) days from the date on which the Product is returned to the Company or the dealer.

All repairs to the Product must be performed by a service center certified by the Company. Any modifications or repairs performed by unauthorized centers or groups will void this warranty.

The warranty period for certain accessories is 90 days. Accessories consist of Lead Wires, Operator Remote, Electrodes, Patient Data Cards, and Nylatex®.

The warranty period for the Therapy System Cart, Battery Module and Ultrasound Applicators is one year (12 Months).

To participate in warranty coverage, this Product's warranty registration card (included with Product) must be filled out and returned to the Company by the original owner within ten (10) business days of purchase.

**This Warranty Does Not Cover:**

- Replacement parts or labor furnished by anyone other than the Company, the selling dealer or a certified Company service technician.
- Defects or damage caused by labor furnished by someone other than Company, the selling dealer or a certified Company service technician.
- Any malfunction or failure in the Product caused by product misuse, including, but not limited to, the failure to provide reasonable and required maintenance or any use that is inconsistent with the Product User's Manual.

**COMPANY SHALL NOT BE LIABLE IN ANY EVENT FOR INCIDENTAL OR CONSEQUENTIAL DAMAGES.**

Some states do not allow the exclusion or limitation of incidental or consequential damages, so the above limitation or exclusion may not apply to you.

To Obtain Service From Company or the selling dealer under this warranty:

1. A written claim must be made within the warranty period to the Company or the selling dealer. Written claims made to the Company should be sent to:

4717 Adams Road  
 P.O. Box 489  
 Hixson, TN 37343 USA  
 Telephone: 1-423-870-2281 or 1-800-592-7329 U.S.A.  
 1-800-366-6661 CANADA  
 1-423-875-5497 Facsimile

and

2. The Product must be returned to the Company or the selling dealer by the owner.

This warranty gives you specific legal rights and you may also have other rights which vary from location to location.

The Company does not authorize any person or representative to create for it any other obligation or liability in connection with the sale of the Product.

Any representative or agreement not contained in the warranty shall be void and of no effect.

**THE FOREGOING WARRANTY IS IN LIEU OF ALL OTHER WARRANTIES, EXPRESSED OR IMPLIED, INCLUDING ANY WARRANTY OR MERCHANTABILITY OR FITNESS FOR A PARTICULAR PURPOSE.**





# Moving Rehabilitation Foward™



**ISO 13485 CERTIFIED**

4717 Adams Road

P.O. Box 489

Hixson, TN 37343 U.S.A.

Telephone:

1-423-870-2281 U.S.A.

1-800-592-7329 U.S.A.

1-800-366-6661 CANADA

1-423-875-5497 U.S.A. FAX

[chattgroup.com](http://chattgroup.com)

27423E

© 2008 Encore Medical, L.P.

TOC

